



USER MANUAL

NANO⁴

Touch Screen Flight Recorder

Version 3.30, Revision #13



1	Important Notices	5
1.1	Limited Warranty	5
1.2	Sunburned Display Warranty	6
1.3	Battery Information	7
1.3.1	Disposal of Old Electrical & Electronic Equipment	7
1.3.2	Disposal of Waste Batteries	8
2	Packing Lists	9
3	Quick Start Guide	10
3.1	Charging the Device	10
3.2	Turn ON	10
3.3	Setting up Your NANO⁴	10
3.4	Graphic Customisation	10
3.5	Setup NAVBOXES	10
3.5.1	Editing Navboxes	11
3.6	MacCready/Ballast/Bugs Widget Settings	13
3.6.1	Map Shortcuts	14
3.7	Editing Wind	14
4	Basics	16
4.1	The NANO⁴ at a Glance	16
4.2	Technical Data	17
4.3	Power Button	17
4.4	Side Buttons	17
4.5	Four Push Buttons	18
4.6	LED	18
4.7	ALS (Ambient Light Sensor)	19
4.8	NanoPower Cable	19
4.8.1	Available Cables for NanoPower	20
4.9	Level Converter (Green Shrink Wrapped)	20
5	Operation	21
5.1	Powering On	21
5.2	User Input	22
5.2.1	Buttons on the NANO ⁴	23
5.2.1.1	Applying a Longer Push on the Buttons	23
5.2.2	Ins. (D): D will Delete the Selected Point Text Edit Control	24
5.2.3	Selection Control	24
5.2.4	Line Width Selection	24
5.2.5	Colour Selection	25
5.2.6	Checkbox and Checkbox List	25
5.2.7	Slider Selector	26
5.2.8	Spin Control	26
5.3	Normal Operation	26
5.4	Powering Off	26
5.5	Security Void	27
5.6	Connecting to a Computer	27
5.7	Downloading Flights	29
5.8	Uploading Files	29
5.9	Bluetooth Pairing	29
5.10	Charging the Battery	30
5.11	Calibration of the Battery	30
5.12	Storing the Nano⁴	31
5.13	Replacing the Battery	31
6	Working with the NANO⁴	32



6.1	Tree Structure	32
6.2	Main Navigation Screen Description	32
6.2.1	Wind Symbol	34
6.2.2	Thermal Assistant	34
6.3	The Locked Screen	34
6.4	The Info Screen	35
6.5	The FLARM Screen	36
6.5.1	FLARM Symbols	36
6.6	The Waypoint Screen	36
6.7	The Task Screen	37
6.8	The Setup Menu	38
6.8.1	QNH	39
6.8.2	Flight Recorder	39
6.8.3	Display	40
6.8.4	Graphics	41
6.8.4.1	System	42
6.8.4.2	Vario	42
6.8.4.3	Map	43
6.8.4.4	Airspace	44
6.8.4.5	Waypoints	44
6.8.4.6	Glider & Track	44
6.8.4.7	Task	45
6.8.4.8	FLARM	45
6.8.4.9	Thermal Assistant	46
6.8.4.10	Wind	46
6.8.5	Connect	47
6.8.6	Warnings	50
6.8.6.1	FLARM Warnings	50
6.8.6.2	Airspace Warning	50
6.8.6.3	Altitude Warnings	51
6.8.7	Task	51
6.8.7.1	Obs. Zones	52
6.8.7.2	Event Start Procedure	53
6.8.8	Hardware	53
6.8.8.1	Vario	54
6.8.8.2	ENL	54
6.8.8.3	Communication	55
6.8.8.4	Sounds	55
6.8.8.5	Battery	56
6.8.8.6	Wi-Fi	57
6.8.8.7	IP NMEA	58
6.8.9	FLARM	59
6.8.10	Files	59
6.8.10.1	Airspaces	60
6.8.10.2	Waypoints	60
6.8.10.3	Map	60
6.8.10.4	FlarmNet	61
6.8.10.5	IGC to KLM	61
6.8.11	Units	62
6.8.12	Logbook	62
6.8.13	Polar & Glider	63
6.8.14	Wind	65

6.8.15	Password	65
6.8.16	About	66
6.8.17	Shutdown	66
7	FLARM Data on the NANO⁴	67
7.1	Connecting a FlarmMouse to the NANO ⁴	67
7.2	Connecting a FLARM to the NANO ⁴	68
7.3	Connecting a FLARM to the NANO ⁴ using the NanoPower-FL	68
7.4	Connecting a FLARM/PFlarm to the NANO ⁴ using the NanoPower-PF	68
7.5	Connecting a LXxxxx Flarm port to the NANO ⁴ using the NanoPower-FL	69
7.6	Connecting a LXxxxx PDA port to the NANO ⁴	69
7.7	Connecting a LXxxxx PC port to the NANO ⁴	69
7.8	Connecting NANO ⁴ with Serial Number less than 06099	69
8	Configuring the NANO⁴	71
8.1	Declarations	71
8.2	Directly on the NANO ⁴	71
8.2.1	Pilot Information	71
8.2.2	Declaration and Editing of a Task	71
8.3	On a PC with NanoConfig for Windows	73
8.3.1	Using the NanoConfig Program	74
8.3.1.1	Pilot Information	74
8.3.1.2	Task Declaration	74
8.3.2	Changing Parameters with NanoConfig	75
8.3.2.1	Flight Recording Interval	75
8.3.2.2	Automatically Finish Flight	75
8.3.2.3	Start Recording on Power On	75
8.3.2.4	Automatically Turn Off Nano4 When a Flight Ends	76
8.3.2.5	Bluetooth	76
8.3.2.6	NMEA Output	76
8.4	Using Bluetooth or Serial Interface	76
8.5	NanoConfig for Android Devices	76
8.5.1	Connecting and Pairing the NANO ⁴	77
8.5.2	Logbook	78
8.5.3	Pilot	79
8.5.4	Task	79
8.5.5	Settings	80
8.5.6	Files	81
8.5.7	Updates	81
9	Updating Firmware	82
9.1	Manual Update	82
9.2	Updating with NanoConfig	82
9.3	Recovery Mode	82
10	Troubleshooting	83
11	Revision History	84

1 Important Notices

The LXNAV system is designed for VFR use only as an aid to prudent navigation. All information is presented for reference only. Terrain, airports and airspace data are provided only as an aid to situation awareness.

Information in this document is subject to change without notice. LXNAV reserves the right to change or improve their products and to make changes in the content of this material without obligation to notify any person or organisation of such changes or improvements.

-  A Yellow triangle shows parts of the manual which should be read very carefully and are important for operating the system.
-  Notes with a red triangle describe procedures which are critical and may result in loss of data or any other critical situation.
-  A bulb icon shows when a useful hint is provided to the reader.

1.1 Limited Warranty

This LXNAV product is warranted to be free from defects in materials or workmanship for two years from the date of purchase. Within this period, LXNAV will, at its sole discretion, repair or replace any components that fail in normal use. Such repairs or replacement will be made at no charge to the customer for parts and labour, provided that the customer shall be responsible for any transportation cost. This warranty does not cover failures due to abuse, misuse, accident, or unauthorised alterations or repairs. LXNAV Instrument displays damaged by direct or magnified sunlight are not covered under warranty.

THE WARRANTIES AND REMEDIES CONTAINED HEREIN ARE EXCLUSIVE AND IN LIEU OF ALL OTHER WARRANTIES EXPRESSED OR IMPLIED OR STATUTORY, INCLUDING ANY LIABILITY ARISING UNDER ANY WARRANTY OF MERCHANTABILITY OR FITNESS FOR A PARTICULAR PURPOSE, STATUTORY OR OTHERWISE. THIS WARRANTY GIVES YOU SPECIFIC LEGAL RIGHTS, WHICH MAY VARY FROM STATE TO STATE.

IN NO EVENT SHALL LXNAV BE LIABLE FOR ANY INCIDENTAL, SPECIAL, INDIRECT OR CONSEQUENTIAL DAMAGES, WHETHER RESULTING FROM THE USE, MISUSE, OR INABILITY TO USE THIS PRODUCT OR FROM DEFECTS IN THE PRODUCT. Some states do not allow the exclusion of incidental or consequential damages, so the above limitations may not apply to you. LXNAV retains the exclusive right to repair or replace the unit or software, or to offer a full refund of the purchase price, at its sole discretion. SUCH REMEDY SHALL BE YOUR SOLE AND EXCLUSIVE REMEDY FOR ANY BREACH OF WARRANTY.

To obtain warranty service, contact your local LXNAV dealer or contact LXNAV directly.

1.2 Sunburned Display Warranty

Any kind of display including LXNAV instrument display screens can be damaged / burnt by strong sunlight magnified by canopies in certain positions. We suggest you protect your device from the direct sunlight, especially when the canopy is open.

LXNAV Instrument displays damaged by direct or magnified sunlight are not covered under warranty.

1.3 Battery Information

A rechargeable battery powers the NANO⁴. The battery can be charged and discharged hundreds of times, but it will eventually wear out. Only use the approved battery and recharge your battery only with approved chargers.

When not in use, unplug the charger from the electrical plug and the device. Do not leave a fully charged battery connected to a charger, as overcharging may shorten its life. If left unused, a fully charged battery will lose its charge over time. Use the battery only for its intended purpose. Never use a charger or a battery that is damaged.

If the battery pack is mishandled, the battery pack can burst, cause a fire or even chemical burns. Observe the following precautions.

- Do not disassemble.
- Do not crush and do not expose the battery pack to any shock or force such as hammering, dropping, or stepping on it.
- Do not short circuit and do not allow metal objects to come into contact with the battery terminals.
- Do not expose to high temperature above 60°C (140°F) such as in direct sunlight or in a glider parked in the sun.
- Do not incinerate.
-  Do not handle damaged or leaking lithium-ion batteries.
- Be sure to charge the battery pack using the supplied battery charger or a device that can charge the battery pack.
- Keep the battery pack out of the reach of (small) young children.
- Keep the battery pack dry.
- Replace the battery pack only with the same or equivalent type recommended by LXNAV.
- Dispose of used battery packs promptly as described in these instructions.

1.3.1 Disposal of Old Electrical & Electronic Equipment

(Applicable in the European Union and other European countries with separate collection systems)



This symbol on the product or on its packaging indicates that this product shall not be treated as household waste. Instead, it shall be handed over to the applicable collection point for the recycling of electrical and electronic equipment. By ensuring this product is disposed of correctly, you will help prevent potential negative consequences for the environment and human health, which could otherwise be caused by inappropriate waste handling of this product. The recycling of materials will be a help to conserve natural resources. For more detailed information about recycling of this product, please contact your local Civic Office, your household waste disposal service, or the shop where you purchased the product.

1.3.2 Disposal of Waste Batteries

(Applicable in the European Union and other European countries with separate collection systems)



This symbol on the battery or on the packaging, indicates that the battery provided with this product shall not be treated as household waste. By ensuring these batteries are disposed of correctly, you will help prevent potentially negative consequences for the environment and human health, which could otherwise be caused by inappropriate waste handling of the battery. The recycling of the materials will help to conserve natural resources. In case of products that for safety, performance or data integrity reasons, require a permanent connection with an incorporated battery, this battery should be replaced by a qualified service staff only. To ensure that the battery will be treated properly, hand over the product at end-of-life to the applicable collection point for the recycling of electrical and electronic equipment. For all other batteries, please view the section on how to remove the battery from the product safely. Hand the battery over to the applicable collection point for the recycling of waste batteries. For more detailed information about recycling of this product or battery, please contact your local Civic Office, your household waste disposal service or the shop where you purchased the product.

(Applicable for Customers in the U.S.A. and Canada)



Lithium-Ion batteries are recyclable. You can help preserve our environment by returning your used rechargeable batteries to the collection and recycling location nearest you. For more information regarding recycling of rechargeable batteries, call toll free 1-800-822-8837, or visit <http://www.rbc.org/>



Do not handle damaged or leaking Lithium-ion batteries.

2 Packing Lists

In the box, you will find:

- A NANO⁴ flight recorder with a preloaded NanoConfig program and a user manual which is loaded on the USB stick



- A Micro-USB cable



- A Wall charger with a Micro-USB plug



- A Level converter (only with NANO⁴ units up to serial number 06099) (green, shrink-wrapped USB adapter)
- A Barogram calibration chart

-  For a NANO⁴ with serial number less than 06099 the packing list also includes level converter which is not needed in newer devices. Please refer to Section 6.6 for more details.

3 Quick Start Guide

3.1 Charging the Device

Fully charge the NANO⁴ before using it:

1. Open the NANO⁴ box and locate the charging cable (Micro-USB) and wall charger.
2. Connect the Micro-USB to the wall charger and the other end to the NANO⁴.
3. Insert the wall charger into the electricity socket.
4. You can also charge your NANO⁴ via USB from a PC.

3.2 Turn ON

To turn on the NANO⁴ press and hold the Power button which is located on the top.



3.3 Setting up Your NANO⁴

After powering on the NANO⁴, confirm the first menu (elevation) and go to the SETUP menu where it is highly recommended to set following settings:

1. Flight recorder (set pilot, registration, recording interval ...)
2. Files -> Waypoints and Airspaces. Load a .CUP file for the WPT and .CUB file(s) for the Airspace.
3. Units
4. Polar and Glider settings
5. Click ABOUT and check whether you have the latest official firmware version on your NANO⁴. To determine the latest official version, see www.lxnav.com (refer to the firmware section).

3.4 Graphic Customisation

In the SETUP menu, under GRAPHICS, it is possible to customise the graphics for the NANO⁴.

3.5 Setup NAVBOXES

It is possible to set 12 navboxes for every navigation page by swiping the bottom row. To change / set up a navbox, touch the navbox and select one from the opened navbox menu.



3.5.1 Editing Navboxes

At the bottom of the map screen, there are four nav boxes, which the pilot can choose. With a longer push on the nav box, the user can select one of several nav box options.

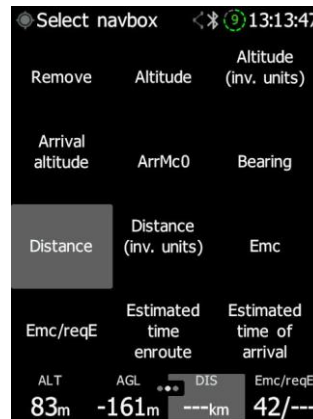

The following nav boxes are available:

Name	Description
Altitude	Altitude above mean sea level (if QNH setting is correct)
Altitude (inv. Units)	Altitude in other units (m<->ft)
Height above takeoff	QFE
Arrival Altitude	Arrival altitude above target at selected Mc
ArrMc0	Arrival altitude above target, calculated for Mc=0 setting
Average vario	Average vario, integration time is set in vario setting
Bearing	Bearing to the target
Closed optimized distance	OLC optimization, if we get home
Comm. Frequency	Frequency of the selected waypoint
Current L/D	Current final glide
Distance	Distance to selected waypoint
Distance (inv. units)	Distance in other units (m<->ft)
Distance from takeoff	Distance from home airfield
E/reqE	Current final glide/Required final glide
Emc	Calculated final glide at chosen Mc
Emc/reqE	Required final glide at chosen Mc/Required final glide
ETA	Estimated time of arrival to selected target
ETE	Estimated time enroute to selected target
Flight time	Time from takeoff
Flight level	Flight level
Gained alt in thermal	Altitude gained from beginning of circling
GPS altitude	Altitude calculated from GPS
Ground speed	Speed over the ground calculated from GPS
Height above ground (AGL)	Height above terrain, calculated from preloaded terrain grid
Optimized distance	Flown distance according to OLC
Requested glide ratio	Required glide ratio to reach the waypoint
Required altitude	Required altitude to reach the waypoint
Speed last hour	Average speed flown in the last 60 minutes.
Task arrival altitude	Arrival altitude above last waypoint of the task
Task distance	Distance to the last waypoint of the task (finish)
Task remaining time	Remaining available time for the given task
Task required glide ratio	Task required glide ratio to reach task finish at chosen Mc

Thermal vario	Average vario from gained altitude and time spent in the last thermal
Track	Track over ground calculated by GPS
Triangle distance	OLC triangle optimisation
Wind	Calculated wind - direction/velocity

To remove a nav box select first option ("Remove").

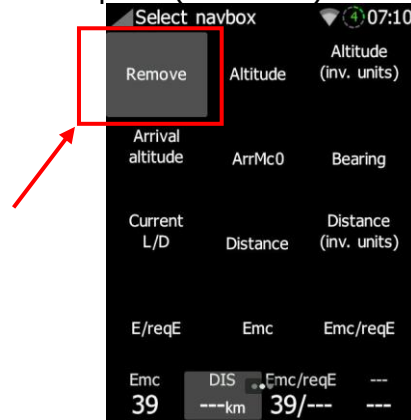

3.6 MacCready/Ballast/Bugs Widget Settings

Touching a MC value on the WPT/TSK screen will open the MC/BALL/BUGS screen.

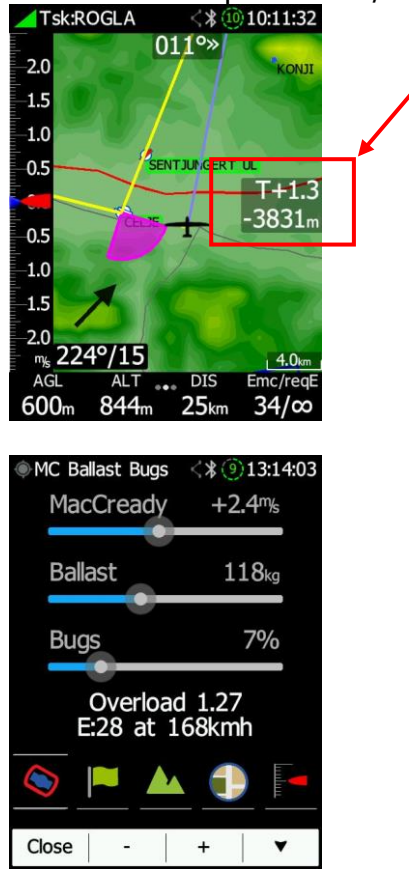

On this screen MacCready, Ballast and Bugs and map shortcuts can be adjusted. At the same time a calculated final glide and speed are displayed on the lower part of the screen.

- 
 If buttons are used for switching between MC, BAL and Bugs, the left button indicates what will be selected by pressing on that button. The active slider is white; others are in a grey colour.

3.6.1 Map Shortcuts

In the same menu just as for the MC/BALL/BUGS it is possible to enabled/disable following options:

- Airspace
- Waypoints
- Terrain
- Map
- Vario

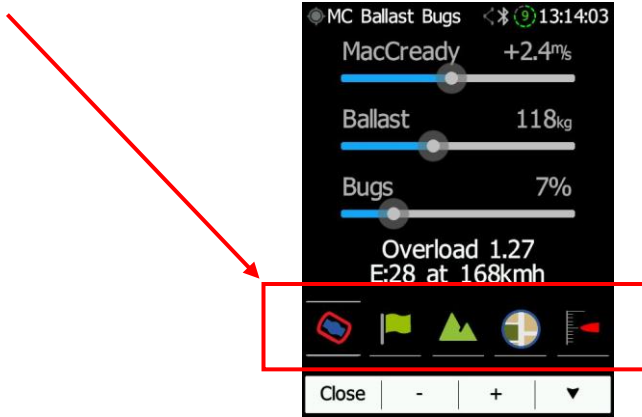

The picture below shows that only terrain and map are active; all other options are disabled

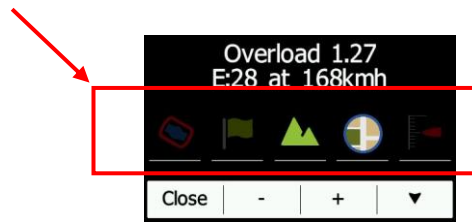

3.7 Editing Wind

The wind editing screen will open after touching a Wind Arrow on the screen.

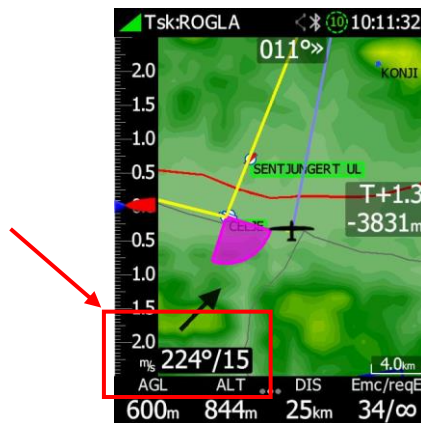

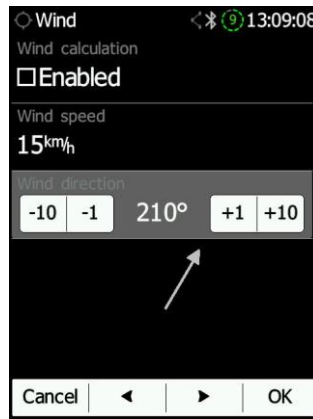



The NANO⁴ will automatically calculate and display current wind information. Alternatively, when this option is disabled, you can enter wind data yourself. You can do this by manually adjusting the wind speed and direction or by simply dragging the arrow over the bottom part of the screen.

4 Basics

4.1 The NANO⁴ at a Glance

The NANO⁴ flight recorder is the smallest flight recorder designed in accordance with the IGC "All Flights" specification. It has IGC approval level 1 for all flights which includes world records. It features an integrated 56-channel GPS receiver with a built-in antenna, an altitude sensor, an ENL sensor, a security micro-switch, a Bluetooth module, a Wi-Fi module and a 2800 mAh battery.

-  The operational temperature for the NANO⁴ is from -20°C (68°F) to +60°C(140°F). Higher temperatures may cause the battery to inflate. The shut down temperature limitation is also -20°C (68°F).
-  Although a WI-FI module is installed its features are currently not yet implemented.

The built-in battery allows up to 36 hours of stand-alone operation. The battery will be charged when the flight recorder is connected to a computer, the NanoPower or a wall charger. Bluetooth is available for easy data exchange with a PDA.



The housing is made of robust ABS plastic. On the right side of the unit there are zoom buttons.

Data storage is on a 4 GB solid state disk. Flights are stored directly in the IGC format and are downloadable through a USB connection compatible with all operating systems (MS Win, Linux and Mac OS).



On the left side of the unit there is a small hole with a reset button. If you need to reset the unit use a pin to press the reset button. In all normal operations this button should never be used.



At the top of the unit there is a micro-USB connector which is used for charging and transferring data. The power button is next to the micro-USB.

The internal solid-state disk is preloaded with the NanoConfig program and the NANO⁴ Manual. This program is used for uploading a flight declaration and/or changing the settings of the NANO⁴. One can also upload flight declarations by using a serial interface cable or a Bluetooth connection by third party applications (SeeYou, XCsoar), or NanoConfig for Android.

4.2 Technical Data

Hardware

- An ARM CPU
- A 4 GB memory solid state memory
- A VGA 640*480 colour pixel TFT sunlight readable LCD
- A 56-channel GPS receiver
- An engine noise level sensor
- A pressure altitude sensor measuring up to 16000 m

Input and Output

- A USB interface (mass storage device)
- A serial RS232 interface for PDA connection
- A Bluetooth interface for PDA connection
- A Wi-Fi interface (in development)

Size and Weight

- Outline dimension: 107x70x18 mm
- Weight: ~150 g

Environmental limitations

- Operating temperature: -20°C to +70°C
- Storage temperature: -30°C to +85°C
- Relative humidity: 0%-95%
- Vibration: +/- 50m/s² at 500Hz

4.3 Power Button

A long press on the power button will power on the NANO⁴. When the NANO⁴ is running a short press on the power button will lock the NANO⁴ screen and shut down the backlight of the screen. Another press will turn the screen back on. A longer press when the screen is on will show a menu "two options, power off, or lock screen" with the options to power off, or to lock the screen.



When flying, a short push on the power button will record a pilot-initiated event, and the flight recorder will then log 30 fixes, with a recording rate of one fix per second.

4.4 Side Buttons

The side buttons have several actions (Zoom, Volume, up/down in menu).



When on an info page, a push on the side buttons will increase or decrease the sound volume. When on the map pages, those buttons will have a zoom function and when in the setup menu you will be able to move from menu to menu.

4.5 Four Push Buttons

The NANO⁴ has four push buttons, which have dynamic functions.



The function of each push button is described on the label adjacent to the button.

The functions of buttons are mostly related to the current page (Waypoint, Task, FLARM, Info, Setup). If there is no label next to a button, this button has no function.

4.6 LED

On the top left corner of the NANO⁴ there is a multi-colour LED indicator.

At power on:

- Hold the power button until the blue light disappears.
- In case of any failure (security check, battery check), there is a red flash with a one Hz period.

Bluetooth operation (only when the screen is off):

- At initialisation there are rapid blue flashes (blue fast) with a 5 Hz period.
- In normal operation blue flashes occur every two seconds.

Battery (when the screen is off):

- When the NANO⁴ is not charging, there are flashes every 10 seconds.
- When the NANO⁴ is charging, there are red flashes every 2 seconds until it is full (green).
- When the state of charge is below 30% the flashes will be yellow; when below 10% the flashes will be red.

Power off:

- At all times, while holding the power button, red will constantly be displayed.



-  LEDs show the status only when the LCD is off.
- A blue LED blinking means that NANO⁴ is still running.

4.7 ALS (Ambient Light Sensor)

On the top right side there is an ambient light sensor. If you have enabled "automatic LCD brightness" the ALS will adjust the brightness of the screen.

4.8 NanoPower Cable



The NanoPower cable is a special device which converts 12 V to 5 V providing a power supply for the NANO⁴ and a PDA. It also translates a serial signal to match the NANO⁴ signal level and a PDA or computer signal level.



Nano Power is not a part of the package and must be purchased separately.



Connect the red and black wires to a 12 V power supply. Red is positive.

-  The maximum input voltage is 24 Volts.
-  NANOs⁴ up to serial number 06099 need an additional level converter for connection to NanoPower. This converter is included in the NANO⁴ box.

The NanoPower has two plugs. On one end there is a standard USB-A connector. Please use the included USB-A to a micro-USB cable and plug the NANO⁴ on this side. Any standard USB-A to mini-USB cable can also be used. On the other end there is an RJ45 plug which is intended for a PDA or a computer.

-  The RJ45 plug is NOT designed in accordance with the IGC standard. It can be used with the dedicated cable only. Do not plug any unknown cable into it as this may damage the NanoPower circuit.

You will find a pin description on the NanoPower RJ45 in the picture below.

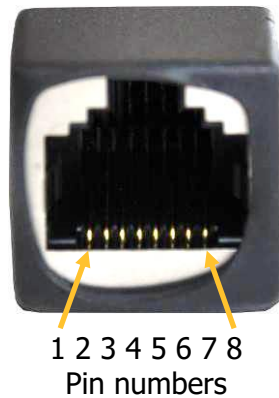

Pin number	Description
1,2	Ground
3	(output) Transmit from NANO ⁴ RS232 (e.g. Computer, V7)
4	(input) Receive toNANO ⁴ RS232 (e.g. Computer, V7)
5	(output) Transmit from NANO ⁴ LVTTTL (e.g. Oudie, HP302)
6	(input) Receive toNANO ⁴ LVTTTL (e.g. Oudie, HP302)
7,8	5V OUTPUT (maximum 1A)

4.8.1 Available Cables for NanoPower

Device	Cable code
OUDIE	CC-NP-OUDIE1
Generic RS232 with female DB9	CC-NP-232
IPAQ 310/314	CC-NP-IPAQ310
IPAQ 38/39xx/47xx	CC-NP-38
MiniMap	CC-NP-LX
Butterfly Connect	CC-NP-BFC
FLARM	CC-NP-IGC
NanoPower for PowerFLARM	NanoPower-PF
NanoPower for FLARM	NanoPower-FL

4.9 Level Converter (Green Shrink Wrapped)

This is only used with NANO⁴ serial numbers less than 06099. It is not needed with newer devices. Please refer to Section 6.6 for more details.

5 Operation

There are two modes of operation: **Data transfer** mode and **Normal operation** mode.

When in the data transfer mode, flights can be downloaded, and waypoints, airspaces or maps uploaded by using standard method of copying files. The NanoConfig program can also be run to edit task or change settings.

When in **data transfer mode**, there will be a message on the screen "USB Connected" followed by "USB mounted". This indicates that the NANO⁴ Flight recorder is in transfer mode. To unmount the USB simply press any key on the NANO⁴ and it will go to normal operation mode.

When in **Normal operation mode** the logger is ready to record flights.

The mode in which the NANO⁴ is operating can be determined from the main screen, or the LED when the screen is off.

5.1 Powering On

There are three ways to power on the NANO⁴ flight recorder.

Press the power button and the NANO⁴ will power on. It will go directly to normal operation mode. On start-up a splash screen will appear with information containing the Serial number. The NANO⁴ will then continue with the "Set elevation" page.

Connect the NANO⁴ to a computer using a USB cable. It will automatically power on and offer to go into data transfer mode. If the NANO⁴ is in data transfer mode and the USB cable is unplugged, the NANO⁴ will shut down.



- When in the data transfer mode, if you press any button, the NANO⁴ will revert to normal operation mode.

Connect the NANO⁴ to the **NanoPower cable**. The NANO⁴ will then automatically power on and after approximately 20 seconds the NANO⁴ will go into normal operation mode.

The normal operating mode starts with the "**Set elevation**" page. The current elevation or QNH setting should be set here. It is also possible to choose to not see this message on every start up.



After clicking "**OK**" or waiting 30 seconds instrument will proceed to the Flight info page. The instrument is now ready to use. In the left upper corner the GPS status is displayed. The

NANO⁴ has a very sensitive GPS receiver which can sometimes acquire a GPS satellite signal even indoors.

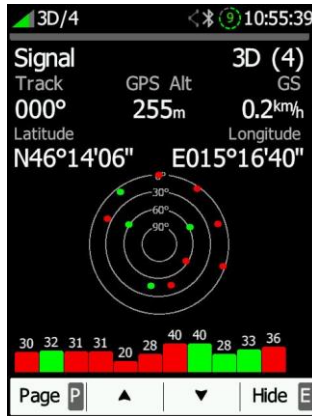

5.2 User Input

The NANO⁴ user interface consists of many dialogues which have different input controls. They are designed to enable the input of names, parameters, etc. as easy as possible. Input controls can be summarised as:

- Text editor
- Spin controls (Selection control)
- Checkboxes
- Slider control
- Line width control
- Colour selection
- "Hamburger" menus

To move the function from one control to the other use the **up** or **down** buttons. By pressing the **Edit** button, it is possible to access the control that is displayed.

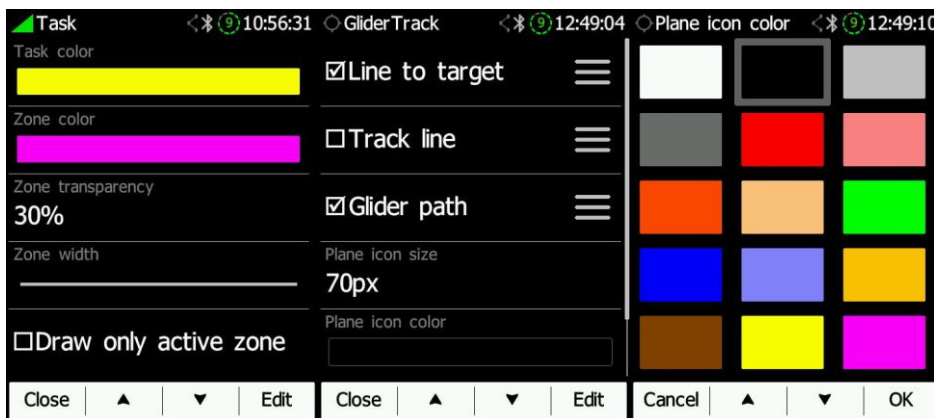

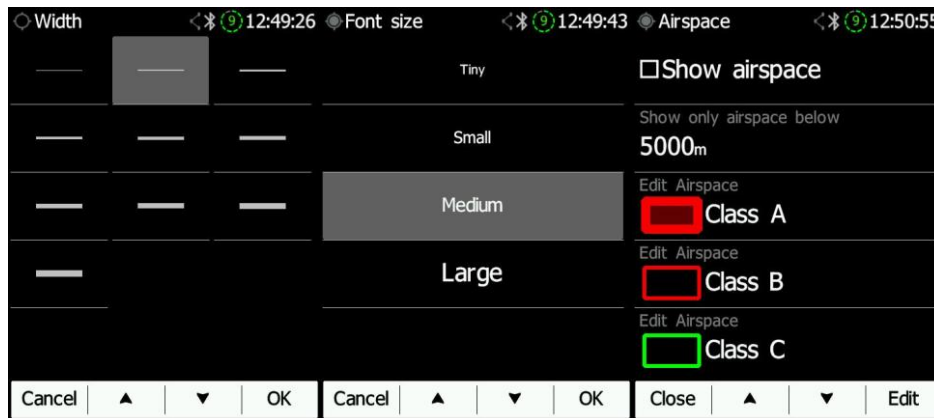

5.2.1 Buttons on the NANO⁴

Buttons have dynamically set functions. Pressing a button will give more options. The main text in the box will perform the action assigned in the context. When you press a button a row will appear with the action assigned to that button in that context.

On the main screen the left button always performs the function of switching between pages. A short push will cycle the pages in one direction. A longer push will cycle the pages in the opposite direction.

A short push means less than a second i.e. almost instant. A longer push means a second but not more. If you hold for longer the NANO⁴ will start cycling through the pages.

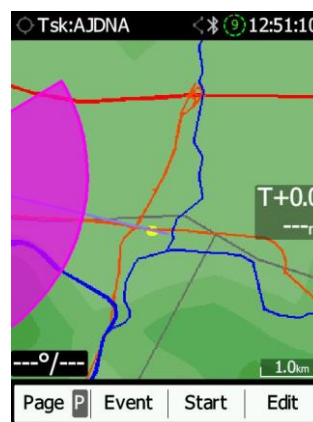

The middle buttons help with target selection by cycling through available targets. The right button has an EDIT /SELECT or EVENT function, where you can edit/view the currently selected target.

5.2.1.1 Applying a Longer Push on the Buttons

Page (P): P will cycle the pages in the opposite direction.

Sort (X): X will exit from the menu.

Next (P): P will move the cursor back.

OK (C): C will cancel the performed action.

5.2.2 Ins. (D): D will Delete the Selected Point Text Edit Control

Use the Text Editor to input an alphanumeric sequence; the picture below shows typical options when editing text. Use the keyboard on the touch screen or the up/down button to change the value at the current cursor position.



Pushing the **next** button will move the cursor to the right. A longer push on **next(P)**, will move cursor left. At the last character position pushing the button will confirm the edited value; a long press **OK(C)** will cancel editing and exit that control. If a longer push is available, part of the button label will be shown red. For example, on the above a longer push on the left button **next(P)** has a back function. A longer push on the right button has the Cancel function.

5.2.3 Selection Control

Use selection boxes, also known as combo boxes, to select a value from a list of pre-defined values. Use the up/down buttons to select the appropriate value.



5.2.4 Line Width Selection

Use line width boxes to select a line width from a list of predefined values. Use the up/down buttons to select the appropriate width.

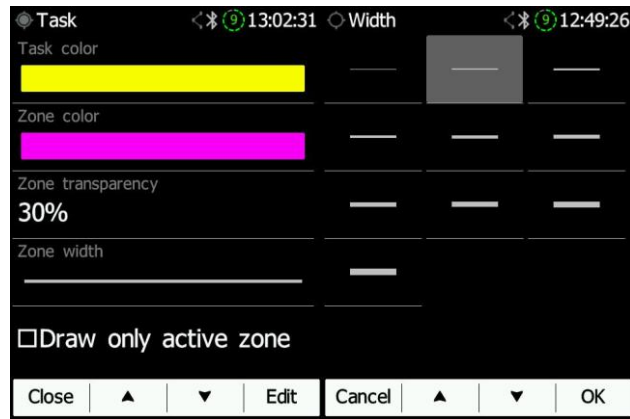

5.2.5 Colour Selection

Use colour selection boxes to select a colour from a list of predefined colours. Use the up/down buttons or touch to select the appropriate colour.

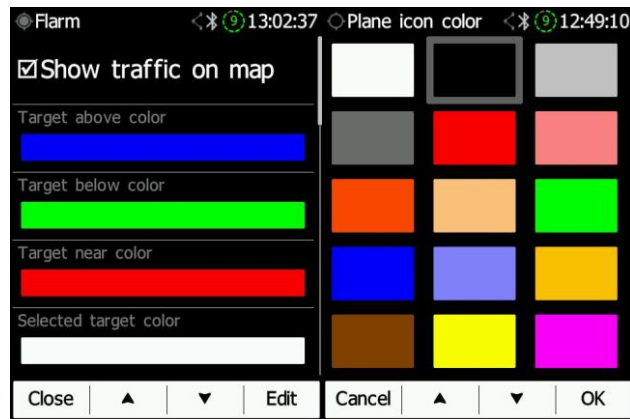

5.2.6 Checkbox and Checkbox List

A checkbox enables or disables a parameter. Press the **EDIT** button to toggle the value. If an option is enabled a check mark will be displayed, otherwise an empty rectangle will be displayed.

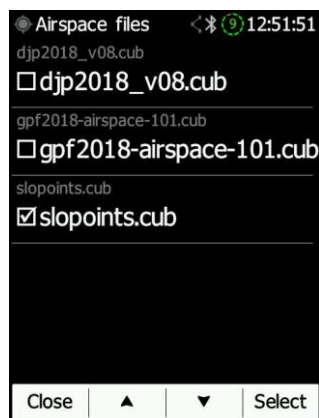

5.2.7 Slider Selector

Some values such as volume and brightness are displayed as a slider.

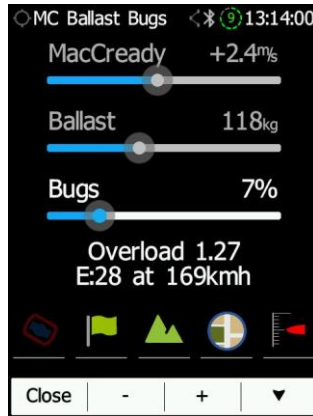

With **Edit** or a press on that area of the screen you can activate the slider control, then with the **Up/Down** buttons or slide on screen you can select the preferred value and confirm via the **Ok** push button.

5.2.8 Spin Control

Using the touch screen, you can increment or decrement selected values. The same action is possible also with the buttons.

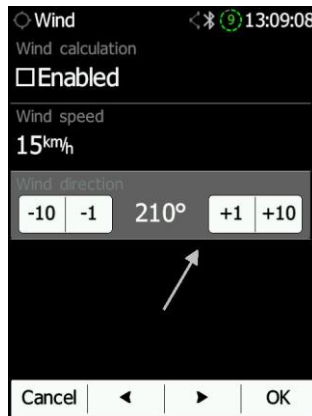

5.3 Normal Operation

There are four active pages and one additional page (Information page, Waypoint page, Task page, Setup page and FLARM radar – if FLARM/PowerFLARM is connected). You can read more about all these pages in Section 6.1.

If the screensaver function is enabled the screen will turn off after the set time in seconds. When the screen saver is on the pilot can still see the indicated status of the NANO⁴ by monitoring the LEDs.

5.4 Powering Off

Holding down the power button will give two options: Lock screen or Power off. Click Power off.

The NANO⁴ can be also powered off from the menu. The Shutdown menu will give you the same possibilities as the power button on top of the NANO⁴.



5.5 Security Void

When the security (secret key) is lost at power on the red light will be blinking and a "DIGITAL SIGNATURE FAILED" message will appear on the screen. To continue press any button. The Nano will be totally functional, but the flight will not be valid under IGC rules.

-  To produce IGC-certified files the NANO⁴ flight recorder must be returned to the dealer or manufacturer for resealing.

5.6 Connecting to a Computer

You can connect the NANO⁴ to a PC regardless of whether it is on or off. If it is off it will connect automatically. If the NANO⁴ is already powered on, it will ask you if you want to connect to a computer.

-  If the NANO⁴ is connected to a computer during flight and if the user confirms a USB connection, the flight will be forced to end.

Connect the NANO to a computer using the supplied USB cable or any other standard USB-A to micro-USB cable. The NANO⁴ flight computer will be identified automatically and a new removable storage device will be indicated. The name of the device will be NANO4_<SERIALNUMBER>.

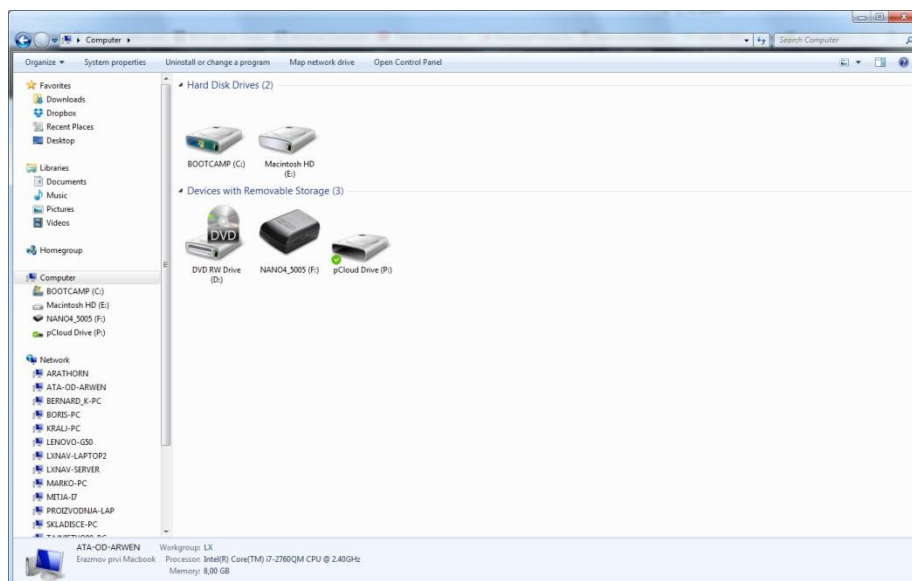

Open this device to see its content.

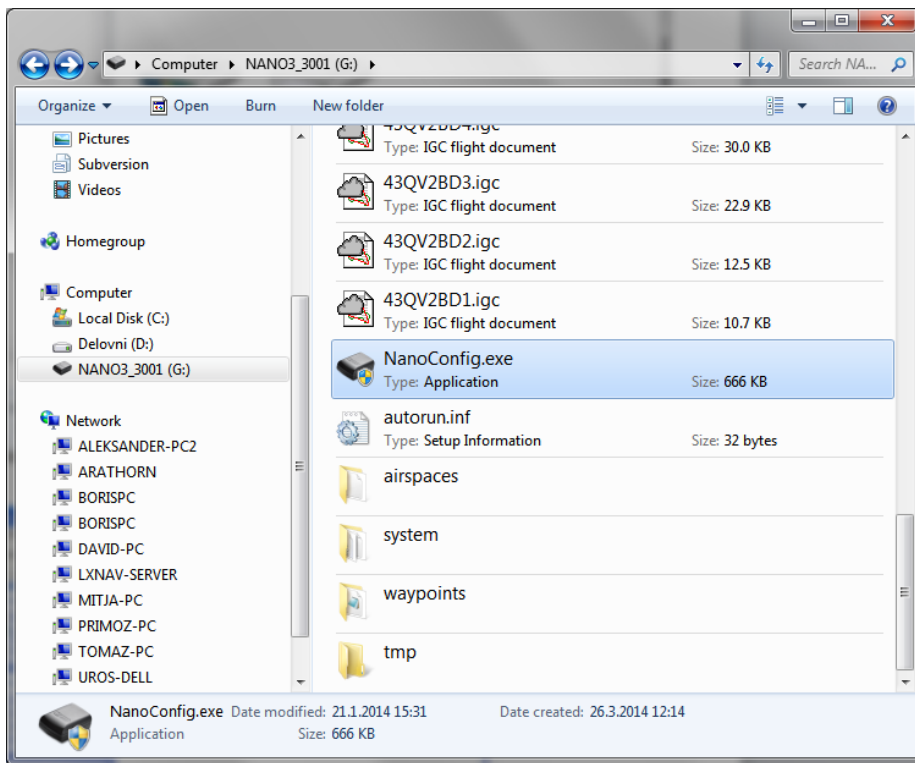

In the root folder you will find the flights created by the NANO⁴ together with the NanoConfig program. The NanoConfig program will run only on Microsoft Windows operating systems. Double click to run it.

-  On the first connection of the NANO⁴ to a computer, it may not be recognized immediately. Disconnect the NANO⁴ from the computer and connect it again for it to be recognized.

5.7 Downloading Flights

Turn off the NANO⁴ and connect it to a computer using a USB cable. From the computer navigate to the root folder of the NANO⁴ and use your preferred method of copying files.

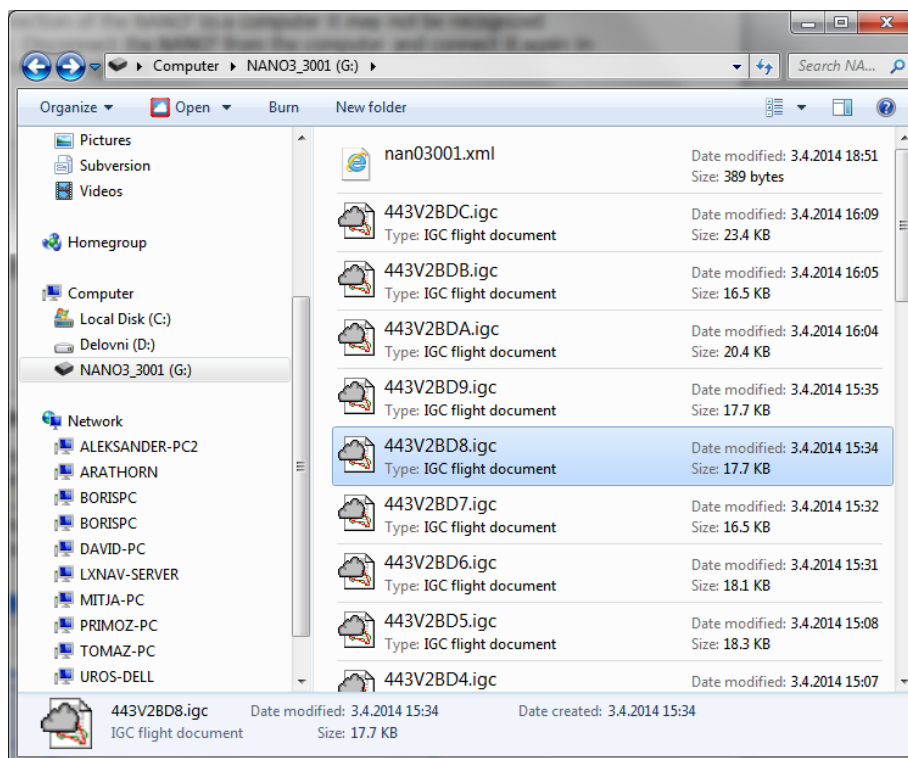

Flights are stored on files with the IGC standard filename. If you find it difficult to decode this standard, we recommended that you switch to detailed view to see the date of the file. In the detailed view the file date and time shows the landing time of the glider.

You can also download flights using the NanoConfig for Android devices. More details are in Section 8.5.

5.8 Uploading Files

Waypoint, Task, Airspace, FlarmNet and map files can be transferred from your computer to the NANO⁴ using your preferred copying method. Place the files into the corresponding folder inside your NANO⁴ root folder (for example: Copy waypoint (.CUP) files into the waypoints folder).

5.9 Bluetooth Pairing

To connect to the NANO⁴ via Bluetooth you must search on a PDA for Bluetooth-enabled devices within range (refer to Section 6.8.8.2 for how to enable Bluetooth). The NANO⁴ will be identified as LXNAV-NANO4-<SERIALNUMBER>. Click PAIR or CONNECT to connect to the NANO⁴. A security pin must be entered. The pin code for the NANO⁴ is **1234** and cannot be changed.



The NANO⁴ can only behave as a client device. In order to connect a NANO⁴ to any other device that device needs to have host capabilities.

5.10 Charging the Battery

The battery will be charged when the NANO⁴ is connected to the external power through a USB port. It can be charged from a wall adapter, directly from a PC or from the NANO⁴ power cable.

If you want a faster charge, you must connect the NANO⁴ to a power supply, wait for it to boot up and then press the button to switch the unit off. In this mode all the NANO⁴ functions (GPS, Bluetooth, Memory) are turned off and this will increase the charging speed.



In this mode the NANO⁴ can be fully charged in approximately 6 hours. The screen is still on but the backlight is off. It is still possible to monitor the level of charge. The level of charge is also visible via the LED.

-  Sometimes it may appear that the NANO⁴ battery level when connected to a charger looks full. However, when you disconnect the power the battery level drops to 90%. This is normal as the battery level indication is different when the charger is connected from when it is disconnected. To fully charge the NANO⁴, please continue charging for a few hours. In the fast charge mode this will take less time. Charge current must drop close to 0 mA or you will see indication FULL.
-  The battery is fully charged when FULL battery status is displayed. This status appears when the current drops below 5 mA and the battery voltage is more than 4.20 V.
-  Temperature limitations for charging NANO⁴ battery are: > 0°C (32°F) and < 50°C (122°F)

5.11 Calibration of the Battery

You can calibrate the battery in the following way.

1. The NANO⁴ must be fully charged.
2. The NANO⁴ is fully charged when the charge current drops below 5 mA, or there is a message FULL.
3. Disconnect the supply cable and leave the NANO⁴ running until it shuts down due to the battery being empty.

-  To be certain that the NANO⁴ is really in discharge mode, the Battery Status row of the INFO page text will show "DIP", which means Discharge in Progress.
-  You can increase the speed of the discharge cycle if you turn on the Bluetooth module, set up brightness of LCD to maximum and turn off the screen fade.

After this procedure the NANO⁴ has measured its battery capacity and with the next charge the indication will be more accurate.

The calibration of the battery is performed during the production of the NANO⁴. In case that calibration data is wrong, a calibration cycle is necessary for a correct indication of the charge level.

-  If the charge level does not show a correct value compared to the battery voltage it is necessary to perform a battery calibration cycle. Example: Charge level: 99% and measured voltage 3.6 V.

5.12 Storing the Nano⁴

The NANO⁴ must be stored in a dry environment with a temperature lower than 25°C (77°F). If you do not intend to use the NANO⁴ for an extended time it is recommended that you charge the battery to 50% beforehand.

The NANO⁴ and the battery have protection circuits which protect the battery from being overcharged or overly discharged. If you store the NANO⁴ with an empty or nearly empty battery eventually the battery will be discharged so much that it will not be possible to charge it again.

5.13 Replacing the Battery

Users cannot replace the battery in the NANO⁴. Replacement of the battery can be carried out only by an authorized dealer. When the NANO⁴ housing is opened the digital signature will be lost and flights will not be signed any more. Resealing by an authorized dealer is then necessary.

6 Working with the NANO⁴

6.1 Tree Structure

The NANO⁴ has 5 modes: Info, FLARM (if FLARM is connected), Waypoint, Task and Setup mode.

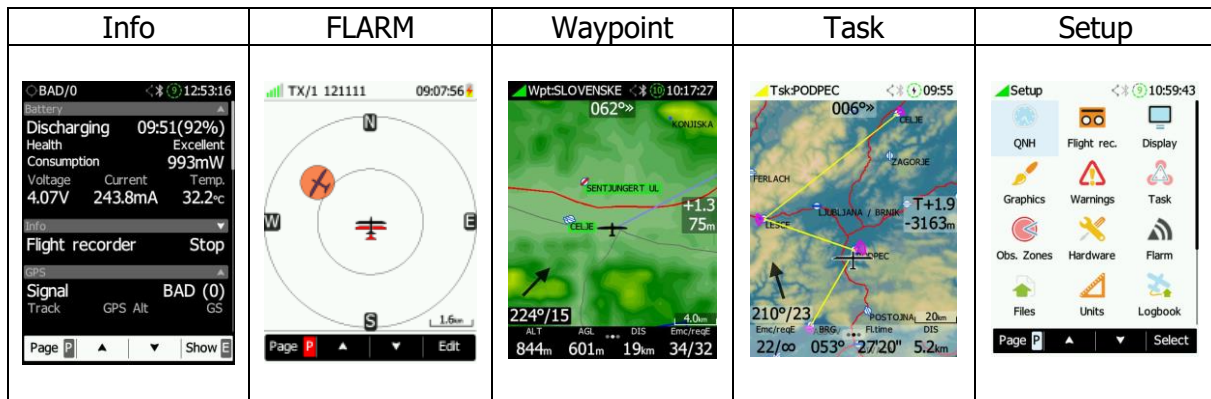

6.2 Main Navigation Screen Description

The main navigation screen consists of a map, terrain with coloured airspace, waypoints with names or task (depending on which page you are looking at), a vario tape (optional) on the left, wind symbol, final glide indicator, a status bar on the top and navbox bar at the bottom. The vario tape and vario dynamics can be configured in the Setup-Hardware-Vario menu or by clicking on the final glide symbol – on the vario icon. If you don't want to see the vario tape you can disable it.

The status line indicates the status of the GPS and indicates the chosen waypoint that you are navigating to, the status of the Bluetooth device, serial interface, Wi-Fi module, the battery level and time.

The **GPS status** indicates the number of received GPS satellites. A green signal indicates a good GPS signal, Red means a bad GPS signal.

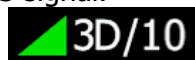







If the **Bluetooth** receiver is powered on the Bluetooth icon will be displayed.



If the **serial interface** via micro-USB connector is active the icon for serial communication will be displayed.

The **Wi-Fi** icon indicates the Wi-Fi status. 

Wi-Fi is disabled	
Initialisation of Wi-Fi Module. If this requires more than 10 seconds there is most likely an error on the Wi-Fi.	
Not connected to access point (AP).	
Error connecting to AP (wrong name of AP, wrong password, ...).	
Wi-Fi module in sleep mode.	
Connected to AP with different signal strengths (left strong, right weak).	
Error connecting to server, no Internet.	

The **battery level** can be displayed in two ways: with the classic battery level indicator or a round progress (circle) with a number inside which indicates the remaining hours. Outside progress indicates the percentage of the battery level. When the remaining time is calculated to be less than 1 hour, the indication becomes red and the inside number indicates the remaining minutes, the outer ring shows the progress for the last hour (60 minutes). To change the battery level indicator go to Setup ->Graphic ->System ->Status bar style ->Battery style.



When the battery is charging the indication is as follows: the inside symbol indicates charging; the outer ring is the percentage of the charge.

The accuracy of the battery life measurement depends on how accurate the battery capacity has been measured. More about battery calibration is described in Section 5.11. At the top centre of the map there is an "off course" (steering course) indicator which helps the pilot to fly in the right direction.

Menu buttons appear when you press any of the buttons. Each button has its own function which is described on the button label. The functions of the buttons are mostly related to the page where you are (Waypoint, Task, FLARM, Info, Setup). If there is no label on a button, that button has no function.

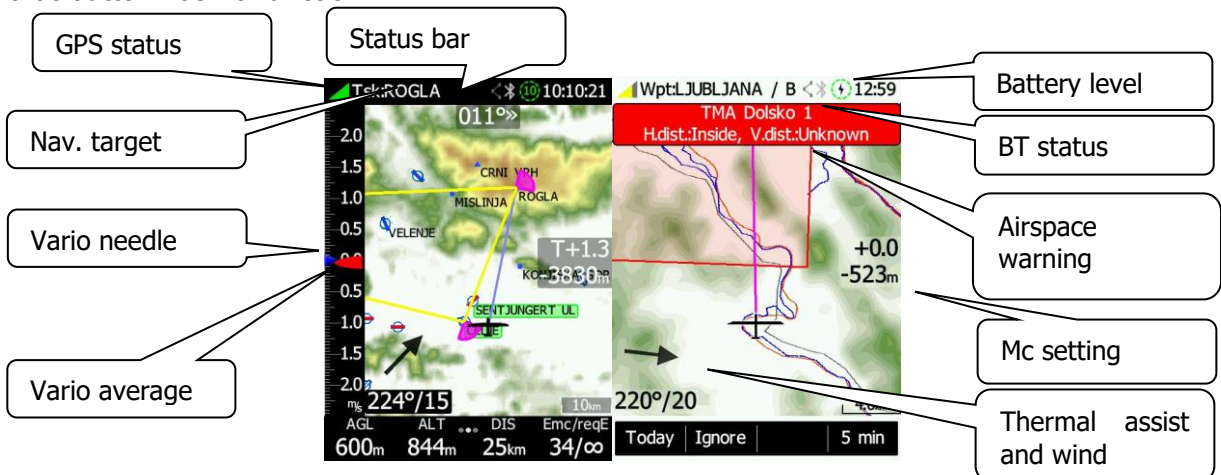

At the bottom of the map screen there is navbox row with 4 navboxes. By swiping the navbox row you can configure up to 12 different navboxes for each page mode. With a long press on the nav box the user can select many navbox options.

6.2.1 Wind Symbol

The wind symbol shows the wind direction. As shown below the first number shows the wind direction which is also indicated by an arrow. The second number represents the wind speed.



By clicking on the wind arrow, it is possible to change the wind calculation from automatic to manual wind setting.

6.2.2 Thermal Assistant

Around the wind symbol a thermal assistant can be shown during circling. Enable or disable this feature in Settings>Graphic>ThermalAssist. The thermal assistant continuously analyses the thermal whilst circling. The sizes of the dots indicate the strength of the thermal. Big dots mean stronger lift at that point. On the left or right side of the circle a small airplane symbol is shown. This airplane indicates your position. Dots are coloured based on the MacCready setting. Red colour means values above MacCready, blue values below MacCready and yellow dots represents lift about the same strength as the MacCready setting.

This colour scheme gives hints about a thermal at glance. If most of dots are red, you should consider increasing the MacCready value; if most of dots are blue, you should consider decreasing the MacCready setting.

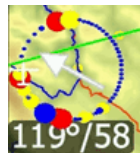

- Thermal assistant settings could be set in the Setup->Graphics->ThermalAssist. menu.

6.3 The Locked Screen

You can lock the screen at any time by clicking on the power button. To unlock the screen, slide your finger over the lock icon left or right as displayed on the screen.



When the screen is locked it will show only the info screen. You can still scroll up and down, but you cannot change or edit anything on the screen.

-  • The info screen can be configured.

6.4 The Info Screen

On the info screen, various data about the NANO⁴ flight recorder can be displayed. You can add new data via the "+" on the right side of the screen. You can choose between the following information:

- Flight info
- Flight recorder
- Altitude
- GPS
- Battery
- Waypoint
- Wind & Thermal.

On the right side of the status bar of each information set is an arrow icon, which closes or opens a dialogue with data.

Once added you can edit each one of them by long clicking on them. You can change the order in which they are displayed by clicking the Up or Down arrow and delete them by clicking "X".



6.5 The FLARM Screen

The FLARM screen is visible only when the NANO⁴ detects a FLARM or PowerFLARM connected to the external port. Selection of FLARM targets and zooming is then available. If the NANO⁴ is connected to a PowerFLARM, it is also able to show PCAS traffic.

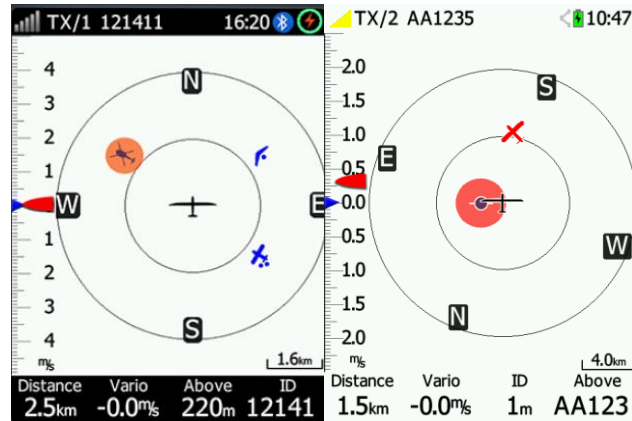

6.5.1 FLARM Symbols



Power FLARM supports symbols depending on the type of the object. Symbols are as shown in the table below:

	Unknown		Para Glider
	Glider		Powered Aircraft
	Tow plane		Jet Aircraft
	Helicopter		Balloon
	Parachute		Airship
	Drop plane		UAV
	Hang glider		

6.6 The Waypoint Screen

The waypoint screen is for navigation to a selected WPT or to NEAR Airport/Wpt. Pressing **Select** allows you to select any waypoint from the CUP file. To choose only landable waypoints press **Near**. Waypoints can be sorted by name, distance or bearing by clicking the **Sort** button.



-  A longer push on the map will bring the near airport/waypoint selection menu around the pressed location on the map.
-  A longer push on the steering course will bring the near airport/waypoint selection menu in the flying direction.

Clicking on different elements on the screen will allow you to edit them. More about editing these elements can be found in Section 7.1.

6.7 The Task Screen

This navigates to waypoints in the defined task. The **EDIT** icon allows you to create a task / insert or delete WPTs. More about this in Section 8.2.2.



-  A long push on the map will open the **GO-TO** menu. When a Waypoint/Airport is selected the NANO⁴ will return to the waypoint page.

Clicking on different elements on the screen will allow you to edit them. More about editing these elements can be found in Section 7.1

6.8 The Setup Menu

The setup menu consists of following pages:

- QNH
- Flight recorder
- Display
- Graphics
- Connect
- Warnings
- Task
- Observation zones
- Hardware
- FLARM
- Files
- Units
- Logbook
- Polar&Glider
- Wind
- Password
- About
- Shutdown

6.8.1 QNH

QNH settings can be changed in this menu. If the QNH setting is correct the NANO⁴ will show the correct altitude. This is the same page that also appears on power-on. This can be disabled by unchecking the **Show dialogue** option.



-  A wrong QNH setting will have an effect only on wrong altitude warnings and a wrong final glide calculation. The QNH setting has no influence over the recorded altitude in the IGC file.

6.8.2 Flight Recorder

Pilot's information and glider data can be configured in this menu:

- The **Pilot's** name must be entered here.
- The **Co-Pilot's** name must be entered here, if the glider is a double seater.
- The **Competition sign (callsign / number)** of the glider.
- The **Registration number** of the glider.
- The **Recording interval** sets the interval when the GPS position is stored in flight.
- **Auto Finish** will allow the automatic finish of the flight under certain conditions. Uncheck this item for wave flying (ground speed is used to indicate the end of a flight and in wave it is possible to be stationary or even fly backwards in relation to the ground).
- When **Auto power Off** is enabled it powers off the NANO⁴ 30 minutes after the flight is finished.
- **Always on** will force the recording/write position to an IGC file immediately after power on. Normally the NANO⁴ logger is triggered by a ground speed exceeding 40 km/h or a vario exceeding 1 m/s. Hang glider pilots are advised to use this function.
- The **Pilot's weight**
- The **Co-pilot's weight**
- **Enable MOP recording** is advised to be used when using a NANO⁴ for JET gliders. This setting can be changed only when flight recorder is not running (Is Stopped).



6.8.3 Display

The display settings can be configured in this menu.

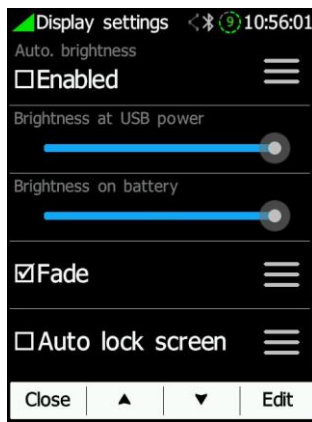

- **Automatic brightness** can be enabled or defined via a "hamburger" menu.

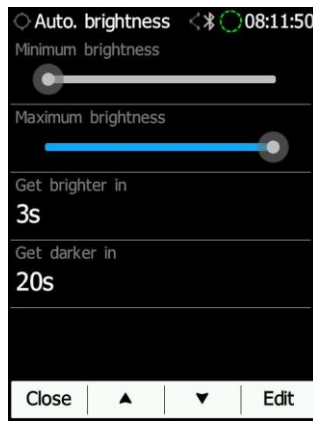

- **Minimum brightness**
- **Maximum brightness**
- **Get brighter in** is the time to reach maximum brightness
- **Get darker in** is the time to reach minimum brightness

- **Brightness at USB power** will set the level of backlight when USB power is present.

- **Brightness on battery** will set the level of backlight when USB power is not present.
- Screen **Fade** enables fading the screen to the level "**Fade brightness**" after "**Fade Timeout**" time.

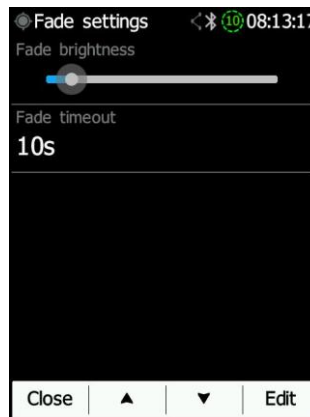

- **Fade brightness** is the level of brightness at which the screen will fade.
- **Fade timeout** is the time taken for the screen will fade to "fade brightness".
- **Auto lock screen** will automatically lock the screen after lock timeout.
 - **Auto lock timeout** is the time after which the screen will lock.
- **Wake on events** enables turning on the screen even if the screen is off.
- **Led brightness** can be adjusted in this menu.

6.8.4 Graphics

Graphics has many sub-items which are related to **System, Vario, Map, Airspace, Waypoints, Glider & Track, Task, FLARM, Therm Assist** and **Wind**.

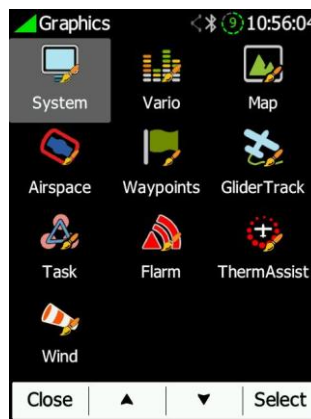

6.8.4.1 System

The NANO⁴ has an option to be configured in a **light** or **dark** theme. Font, Colours and transparency can be adjusted for the navboxes, banners and user messages.

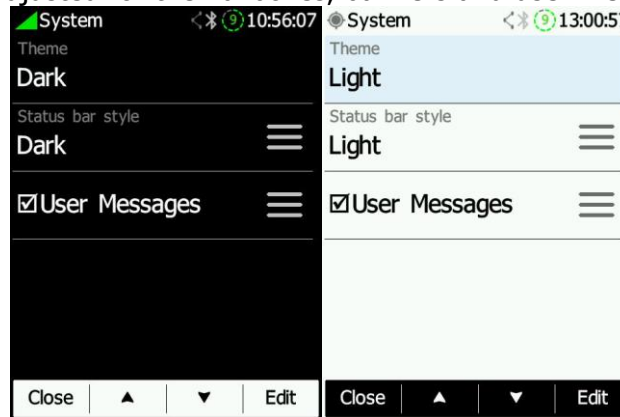

By clicking on the "hamburger" menu of the **Status bar style** you can switch between two battery status styles **Standard** and **With time** (shows how many hours/minutes is left), adjust status bar text colour and enable the seconds on time display.

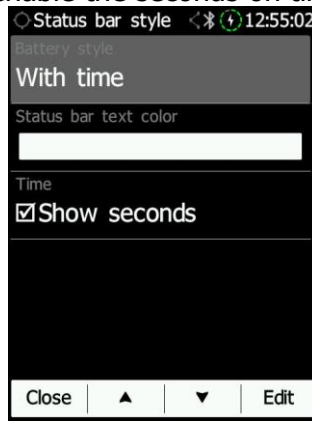

6.8.4.2 Vario

The **Show vario** tape can be displayed or hidden from the WPT and TSK page. The **Vario style can** be dark or light. The scale colour can also be set for **positive** as well as for **negative** readings of the vario. **Dynamic scale** moves with the cursor up or down.



6.8.4.3 Map

Map graphics with widgets can be set here.

The **Map orientation** can be set to North Up or to Track Up.

Terrain colour scheme can be selected from following settings:

- Atlas
- Cliffs
- Flatland
- Flatland2
- Grayscale
- Himalaya
- High contrast
- Low contrast
- ICAO
- Mountains
- OSM
- Zebra
- Zebra2

Map elements such as water, roads, highways etc. can be modified in the **draw map** menu. The **Steering Course** widget is seen at the top of the WPT and TSK page, while the **MacCready widget** is seen in the centre of page on the right-hand side. Background colour, transparency, font colour and font size can be configured here.

Navbox graphics, such as colour, transparency, title font colour value font colour and font size can be also configured in the **edit navboxes** "hamburger" menu.



6.8.4.4 Airspace

Airspace colour, width and zoom level visibility for each type and class of the zone can be set in this menu. Click on the airspace class you wish to edit to open its settings.

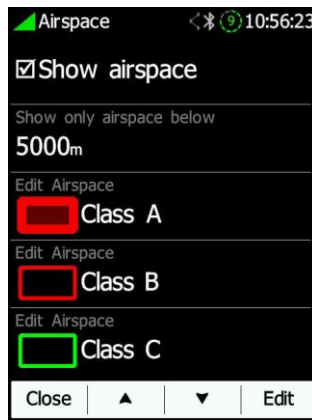

6.8.4.5 Waypoints

Waypoints can be seen if **Show Waypoints** is enabled. When **Colour points in range** is enabled, waypoints that are in the range at that given moment will change colour to green: when on marginal final glide to orange and when not in the range to red colour.

To avoid long names on the map you can reduce the number of characters that are displayed in each label by clicking **Label length** and change their size and colour of the text.

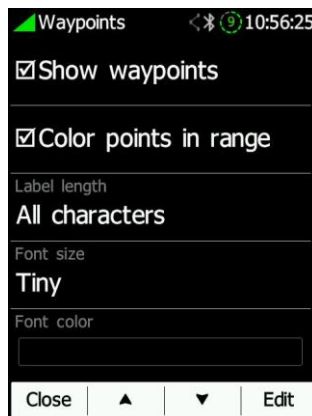

6.8.4.6 Glider & Track

Glider and track settings can be adjusted here. **Line to target** and **track line** can be enabled/disabled; colour and line width can be set under the "hamburger" menu. **Glide path** style can be set to fixed, MacCready value or to the Average vario value. Its colour, width and time length can be also defined. **Plane icon** colours can be changed and the icon size as well.

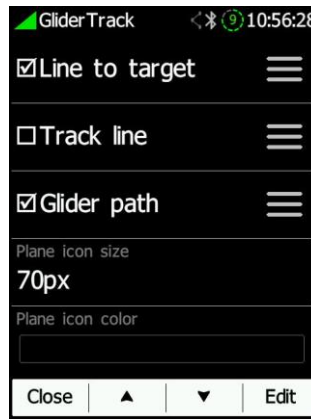

6.8.4.7 Task

Task settings such as task and zone colour, transparency and zone width can be set here. **Draw only active zone** will show only a currently active zone while flying a task.

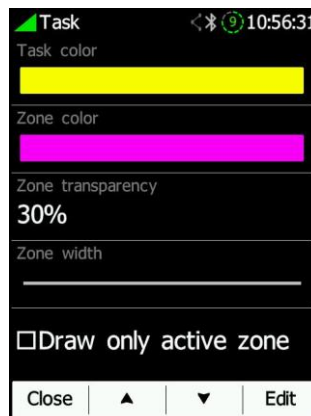

6.8.4.8 FLARM

Show traffic on map can be enabled or disabled. Colours for above/below/near/selected target and font can be set. Additional options are available such as **Bubble** around target, **Draw history**, **Draw line** to target, **Lock on** target, enabling showing of A/C target and changing plane icon size. The **Flarm timeout** defines the time when the user will cease to see a FLARM warning after dismissing the FLARM warning of a FLARM object.



6.8.4.9 Thermal Assistant

The thermal assistant is displayed around the wind icon on the Waypoint and Task page. It can be enabled or disabled.

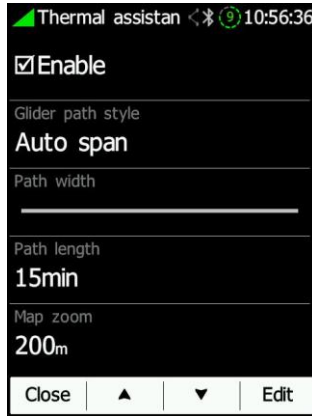

Thermal assistant can **colour circles** by:

- Auto Span: uses lowest and highest vario value from last thermal
- MacCready: uses currently set MacCready value
- Average vario: uses current average vario value

The same settings are valid for the **Glider path style**. Path length and width can be also set.

6.8.4.10 Wind

Wind is displayed on the Waypoint and Task page. The wind symbol can be enabled or disabled. The widget's graphics can be customized such as background colour, transparency, font colour and size, arrow brush colour and arrow's transparency, arrow's pen colour and its width.



6.8.5 Connect

There are five sub items in the www menu:

- **Services**
- **Email**
- **Sign out**
- **Google Drive**
- **Dropbox**

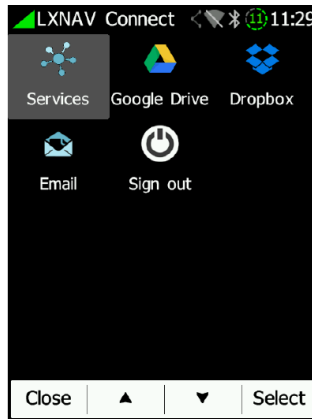



-  Files that you load from Google Drive and Drobox might take a few seconds to show up.

You can connect to LXNAV Connect cloud services. Follow the link or scan the QR code.

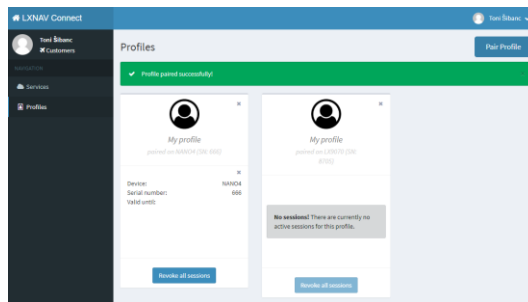
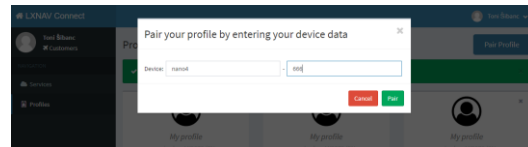
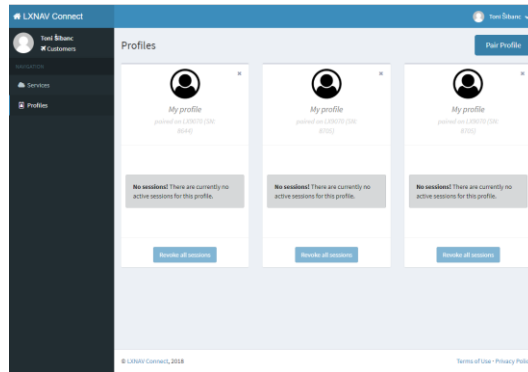

You need to pair your profile with LXNAV Connect account. Pairing is possible also via the website. Just click on **profiles** and then on the **pair profile**.



-  • For manual pairing go to: connect.lxnav.com

When the pairing process has been completed on the web the list of available services will be displayed.

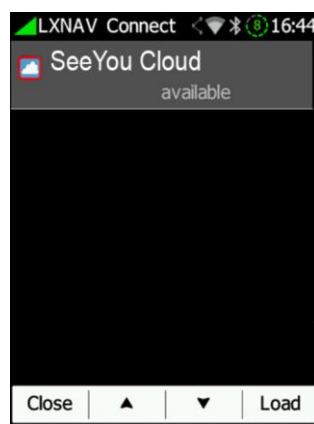

Next time you will sign into your account automatically.

-  Services marked "unsupported" are the ones you have added to your LXNAV Connect profile but are not yet supported on the Nano⁴. You can still use them on other supported devices (for example LX9000).

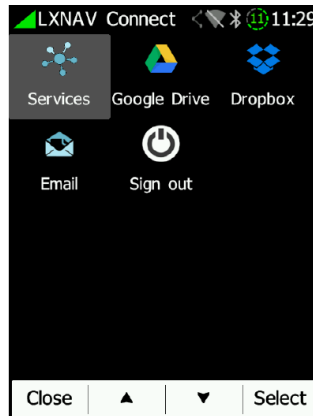

6.8.5.1.1 Email

In this menu you can edit email addresses of the recipients that you send your flights to with the Logbook>Send function. Edit recipients by simply clicking on them. Enter your email address and click OK.

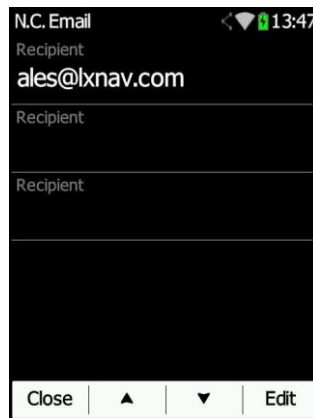

6.8.5.1.2 Sign Out

Here the user can sign out from LXNAV connect. This Nano⁴ will be removed from the list of paired devices on user's LXNAV connect account.

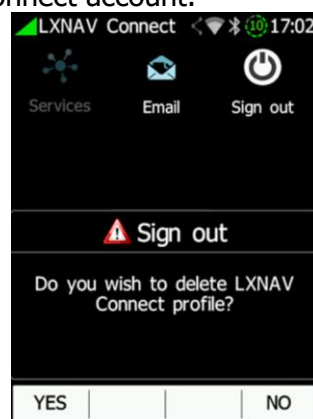

6.8.6 Warnings

The pilot can setup **Airspace alarms**, **Altitude alarms**, **FLARM alarms**, **Gear warning** and their conditions. There is a possibility to **disable warnings in first 3 minutes** of a flight. The **Landing gear warning** will be triggered when **AGL** altitude setting is reached.



6.8.6.1 FLARM Warnings

FLARM warnings are classified into three levels (refer to the FLARM manual for details on www.flarm.com):

- First level (Low) approximately 18 seconds before a predicted collision.
- Second level (Important) approximately 13 seconds before a predicted collision.
- Third level (Urgent) approximately 8 seconds before a predicted collision.

Select each type of FLARM warning to edit its parameters separately.

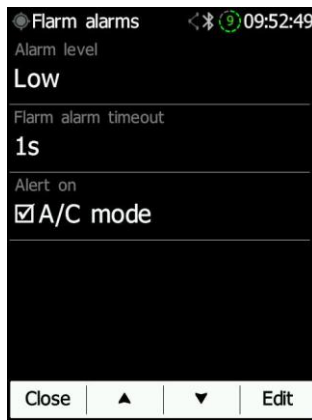

The **Flarm timeout** defines the time when the user ceases to see a FLARM warning after dismissing the FLARM warning of a FLARM object. Alert on A/C mode enables or disables whether an alarm is set off by A/C mode transponders whose location is unknown and whose distance is only approximated.

6.8.6.2 Airspace Warning

The airspace alarm will be triggered at the desired number of **minutes** and **seconds** before entering airspace. You can also set **minimum altitude difference** and **distance** to the airspace for the alarm to be triggered. The alarm for each type of zone/airspace can be enabled or disabled separately.



6.8.6.3 Altitude Warnings

This sets the alarm that is triggered before reaching the desired altitude. There is an option to disable it for the first 3 minutes of the flight (for example during take-off).

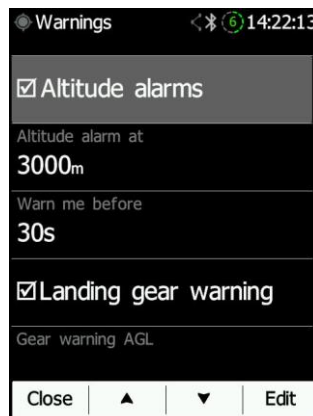

6.8.7 Task

Once a **new** task is created you can **edit** it as described in Section 8.2.2. To **save** the currently open task press **Save**. Saved tasks can later be brought back by clicking **Load** and selecting the task you wish to load. Under task **Options** menu you can change **Gate time**, **Task time** for AAT, and parameters for the **Event start** procedure (section 6.8.7.2). Observation zones can be edit under **Obs. Zones** item (section 6.8.7.1).

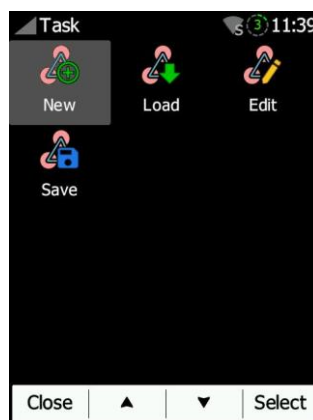

6.8.7.1 Obs. Zones

This menu defines the default observation zone geometry. The following zones can be set: **Start zone**, **Point zone** and **Finish zone**. By clicking **templates** you can pick between three preloaded standard types of zones (500m Cylinder, 500m and start line and FAI and start line).

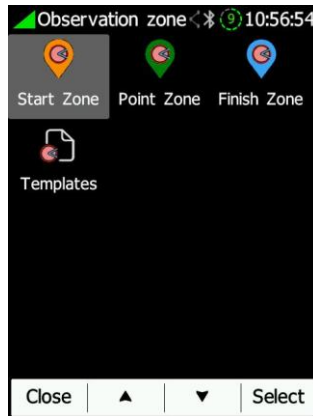

Each type of observation zone is defined with two angles, two radii and a mean bearing (**Angle12**). These parameters enable the creation of any known zone geometry separately for start, turn point and finish points.

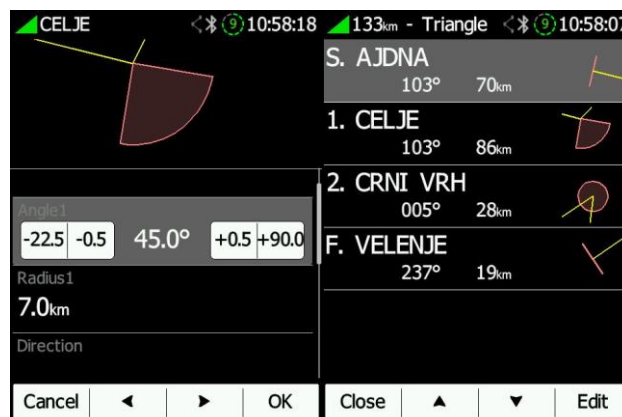

When using parameters in the zone dialogue, it is possible to describe all types of observation zones. **Angle12** defines the orientation of the observation zone. Available values for **Direction** are:

- **Symmetric**: this is the most common selection for a turn point.
- **Fixed**: this is mostly used for assigned areas.
- **Next**: this will move the observation zone in the direction of the outgoing leg. One usually uses this option for the start.
- **Prev**: this will move the zone in the direction of the incoming leg. It is usually used for the finish.
- **Start**: this always moves the sector towards the start.

If the **Line** checkbox is checked the sector will become a line type of observation zone. The **Radius 1** parameter describes half of width of line length. Use the UP/DOWN arrow buttons to increase or decrease radius for step 0.1. A longer push will increase/decrease it up to 5.0.

If **Line** is not checked the **Angle1** parameter will define the basic shape of the observation zone. A value of 180° means that the zone is a cylinder whereas 45° is the classical FAI sector. Use the Up/Down buttons to select the required angle.

Angle2 and **Radius2** are used for more complex observation zone setups.

When changing observation zone parameters, the screen is automatically updated to display the new zone.

6.8.7.2 Event Start Procedure

When **event start procedure (PEV Start)** is in use, pilot must record an event before crossing the start line or exiting start zone. After pressing the EVENT button (right hand button), the wait time period then starts (**Wait before**). When this period finishes, start interval (**Start period**) then commences in which a penalty-free start may be made..

Press EVENT button to trigger event start procedure. An **Event Marked! (x)** message with number of events will appear. If you have enabled nav box for **Event Proc.**, in the Task Setup, you will see the time counting down. For **waiting period**, the title of the nav box will show **WAIT!**. Once the countdown is finished a message "Start window is open." will be shown and start interval countdown start count down, the title will show **GO!** message. When pilot sees this countdown, a penalty free start can be done.

When time of the start window is over, the title of the nav box will show **CLOSED** message. Event button may be pressed at any time, up to a total of **Max.events** times. Each press of PEV cancels the previous start window and restarts the wait time timer.



Multiple events recorded within 30 seconds will be treated as a single event at the time of the first event of the cluster.

On the next timeline a scenario with **Event Proc.** Nav box is shown. It is assumed that wait time interval is 20 minutes, start window is 8 minutes and maximum number of events is three.

The PEV has been triggered at **11:55**. Now we are waiting for **20 minutes**, until **12:15**.

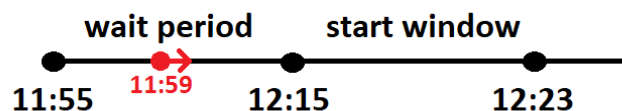

At **12:15**, you will get a message, »**Start window is open**«. Now we have 8 minutes of the time to cross the start line without penalties.

At **12:23** you will get a message »**Start window is closed**«

We can repeat start procedure for »**Max Events**« times. When the number of events exceeded the number of **Max.Events**, there will be a title in the Nav box "**MAX.PEV**".



Times can be set in the Task-Option section

6.8.8 Hardware

There are five sub-items in the hardware menu:

- **Vario**
- **ENI**

- **Communication**
- **Sounds**
- **Battery**
- **Wi-Fi**

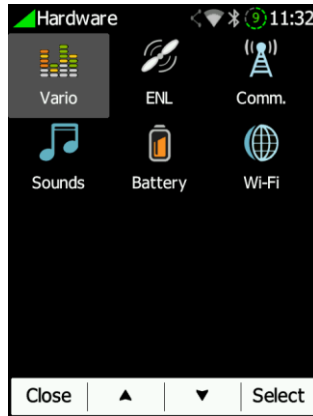

6.8.8.1 Vario

The vario submenu allows you to adjust the **Vario filters** for the **Vario needle** and the **vario sound**, vario tape **range** and **integrator time**.

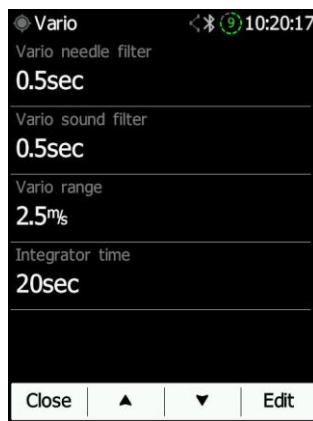

A higher number for the vario filters means a more damped vario signal. Range is the overall scale of the vario type with its maximum and minimum value. With longer integrator times the vario calculates average over the longer period.

6.8.8.2 ENL

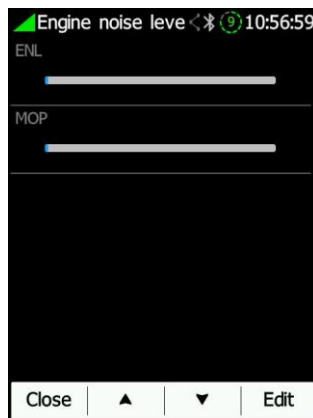

This page is just for monitoring the Environmental Noise Level ENL. MOP (means of propulsion) is provided to detect noises produced from JET engines.

-  Refer to the IGC approval document for the Nano⁴ for how to use the Nano⁴ as a MOP recorder.

6.8.8.3 Communication

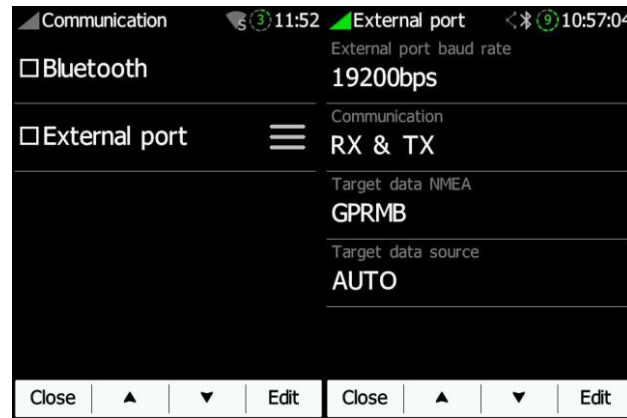

In the communication menu you can enable or disable the **Bluetooth** device, enable or disable the **NMEA output** on the **external** USB port and define the **baud rate** for the external serial interface.

Communication enables you to set the way the NANO⁴ will communicate with the FLARM. **Target data NMEA** enables you to use NMEA data transmission (GPRMB and LXVTARG) to other external GPS devices (Oudie, PDAs, Smart phones...). **Target data source** enables the NANO⁴ to communicate all information about the current target depending on which page you are (Task or Waypoint). **AUTO option** automatically detects the page mode (whether you are in Task or Waypoint page) and sends information about your current target.

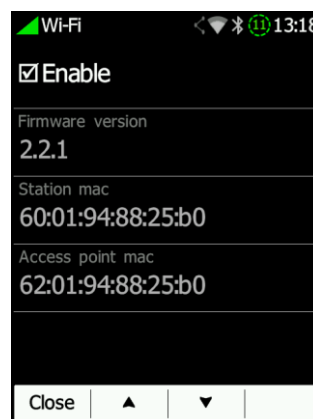

6.8.8.4 Sounds

Various settings for sounds can be adjusted here. **System** and **Vario** sounds can be enabled or disabled. **Flarm traffic alarms** and **beeps** can be also enabled/disabled.

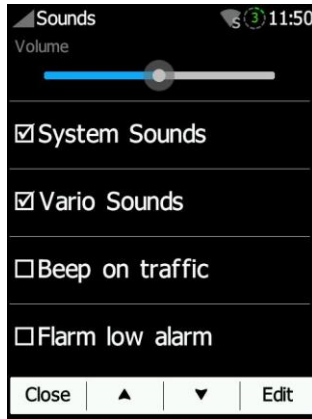

- The vario volume can also be adjusted by using side buttons, but only in the GPS info page.

6.8.8.5 Battery

Battery health and status can be checked in this menu. The following data is available:

- Charge level
- Status
- Health
- Voltage
- Current
- Temperature
- Designed capacity
- Manufacturing date



Voltage is typically between 3,5V and 4,2V. Current depends on the power consumption (LCD brightness, BT, Wi-Fi) and the voltage of battery.

Health is described as:

- Excellent
- Good
- Bad

Contact service (that may indicate end of the life of the battery).

Be advised that user cannot change battery on his own and should contact a LXNAV dealer if this step is necessary.

6.8.8.6 Wi-Fi

On Wi-Fi page are available following items:

- Setup
- Access points
- IP NMEA

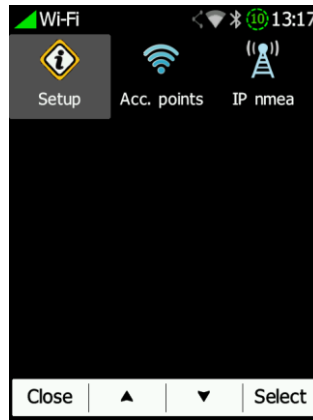

6.8.8.6.1 Setup

In setup the user can enable or disable the Wi-Fi module and see the version of the Wi-Fi firmware and the MAC addresses of the Access point and Wi-Fi module.

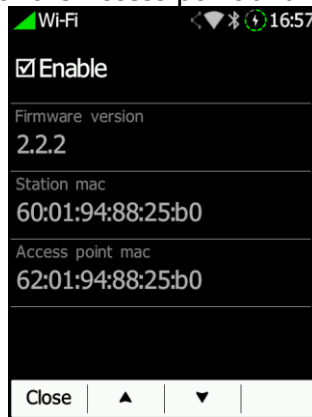

6.8.8.6.2 Access Points

In this menu you can connect to a Wi-Fi access point. All points in range will be shown as well as all stored points (which may not be in range). For this function to work you first must enable the Wi-Fi under Hardware->Communications.

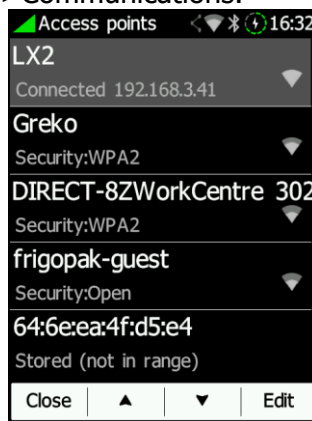

Select the Wi-Fi you wish to connect to and a new menu will open where you can type in the password and enable or disable DHCP.

6.8.8.7 IP NMEA

Here you can enable or disable TCP/IP NMEA sentences. You can also see your Nano⁴ access point (format: NANO4-xxxx) or set-up IP address, port number, netmask and gateway.

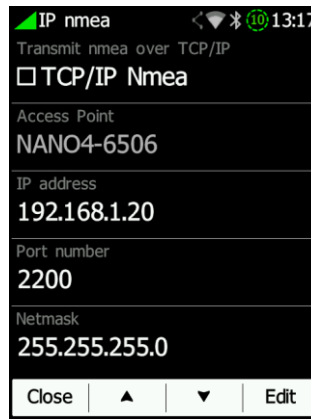

6.8.9 FLARM

If a FLARM is detected the user can make some configuration setting changes on the FLARM and display some FLARM status information.



6.8.10 Files

The NANO⁴ supports **CUP** file format for waypoints only, **CUB** or **ASAPT** file format for airspace, **FLN** for FlarmNet files and **CIT** file format for the maps.

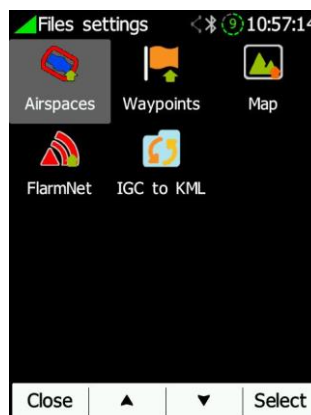

Please refer to Section 5.8 and 6.8.10 on how to upload files.

6.8.10.1 Airspaces

Once your airspace files (**.cub** or **.asapt**) are loaded on to the Nano⁴ select it in **Files->Airspaces**. Selected airspaces will now be displayed on the waypoint and task pages.

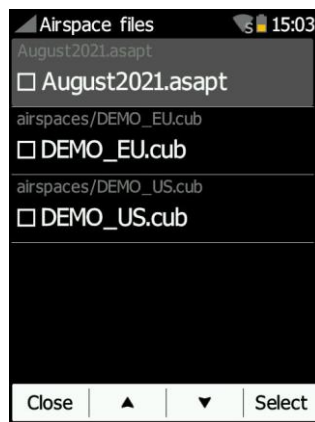

-  The Airspace CUB file is limited to a maximum 5 Mbytes size.

6.8.10.2 Waypoints

Once your waypoints files (**.cup**) are loaded on to the Nano⁴ you can go to the **Files->Waypoints** menu and select the waypoints files you wish to make active.

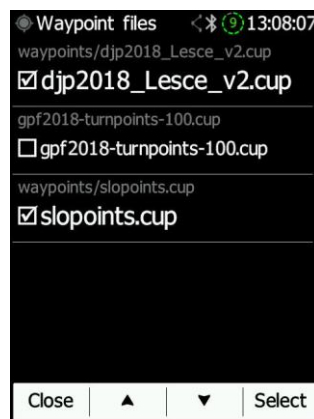

-  The Waypoint CUP file is limited to a maximum 1 Mbyte size.

6.8.10.3 Map

The NANO⁴ can have terrains and maps. To obtain map files (CITv1 or CITv2) please visit:

CITv1: <https://gliding.lxnav.com/citv1/>

CITv2: <https://gliding.lxnav.com/citv2/>

Once downloaded:

- Connect your Nano⁴ to the computer
- Transfer the downloaded map files (**.cit**) to your Nano⁴ (root folder)
- Go to **Setup->Files ->Map** and select the map you wish to use.

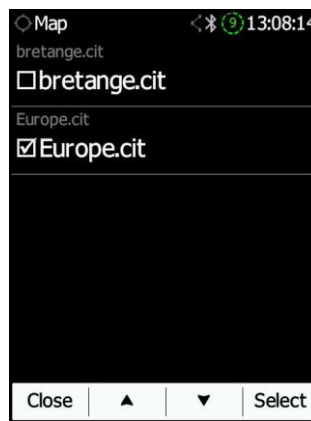

-  Maps are supported only in firmware versions 2.0 or higher.

6.8.10.4 FlarmNet

FlarmNet database files (**.fln**) can be selected here. Go to **File>FlarmNet** and select the file you wish to use. This is useful only when a FLARM is connected to the device.



6.8.10.5 IGC to KLM

The NANO4 can convert all IGC files loaded on the NANO⁴ to KML file format. Simply select the file and press **KML** in the bottom right corner.



6.8.11 Units

The NANO4 has a possibility to load presetted units from the following list:

- Metric
- Imperial
- US
- Custom



The following units can be set:

- UTC offset
- Distance
- Altitude
- Temperature
- Pressure
- Speed
- XCspeed
- Vertical speed
- Wind speed
- Weight
- Load
- Longitude/Latitude
- Ballast

6.8.12 Logbook

All flights recorded by the NANO⁴ are stored and sorted by date in the logbook. The following parameters are recorded: date, take-off & landing times and the duration of the flight. Use the two middle buttons to navigate through the list. A longer push on these buttons will move you faster through the list.



Once your Wi-Fi connection is established you can also send a selected flight by clicking Send in the bottom right of the screen. A new menu will open where you select the email you wish to send your flight to or add new email address.

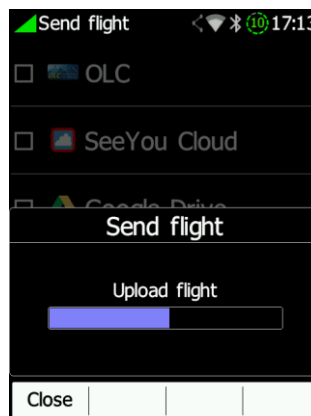
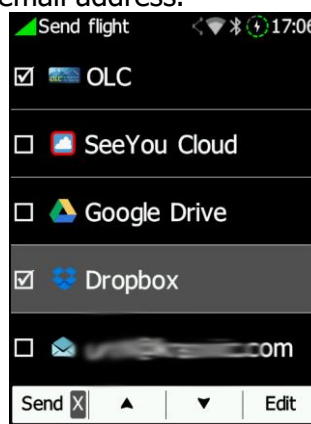

6.8.13 Polar & Glider

The Polar and Glider section allows you to load and edit a set of parameters for the polar of your glider. You can select from a pre-defined list of nearly every common glider or create your own polar.

Select a Glider from the List: this is an alphabetical list of all the common gliders and associated polar data. All glider data will be copied from the chosen polar.

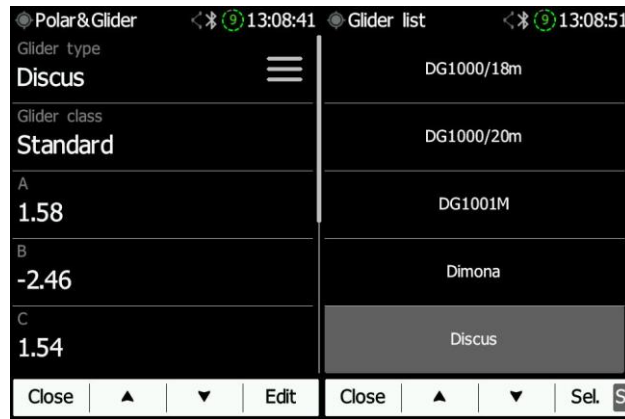

You can modify the polar by changing coefficients **a**, **b** and **c**.
A polar is defined as a quadratic equation with the parameters a, b, and c.

Use the SeeYou program (Tools->Polar) to calculate coefficients a, b and c for a given glider's polar. The program requires three sink points entered at selected speeds (e.g.: 100 km/h, 130 km/h, and 150 km/h). The program will calculate the values of a, b and c, which should be noted and entered into the NANO⁴.

- **Class:** options for Touring, Ultralight, World, Two-seater, Club, 18-meter, 15-meter, Open, Standard and Unknown are available.
- **A, b, c:** options can be adjusted or entered for a non-listed glider.
- **Reference load** (wing loading) value represents the value at which the polar was measured.
- **Reference weight** corresponds to the weight value at which the polar was measured.
- **Maximum take-off weight** is the maximum take-off weight allowed for the glider. It is not used in the calculation; it is just a reminder to the pilot of the maximum take-off weight.
- **Empty weight** is weight of the glider without the pilot and ballast.
- **Pilot weight** is the weight of the pilot with a parachute and some baggage.
- **Co Pilot Weight** is the weight of the co-pilot with a parachute and some baggage.

6.8.14 Wind

In this section the pilot can define a wind calculation method. Select **Manual** to manually adjust the wind speed and wind course. In **automatic** mode this will be performed automatically by the NANO⁴ based on GPS data.

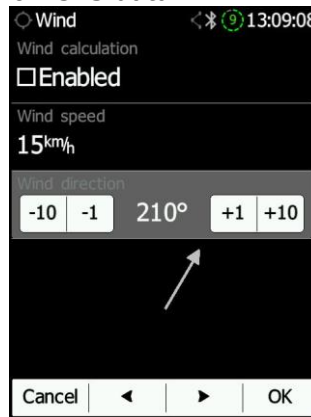

- The pilot can enter wind manually by sliding on the lower part of the screen (arrow).

6.8.15 Password

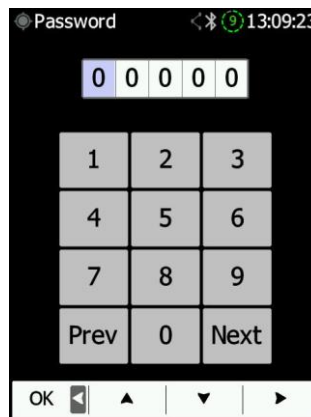

The following passwords are available:

00666 - Resets all settings to factory default.

00667 - Resets the battery calibration to the factory default (to be calibrated the battery will need a new calibration cycle).

32233 - Formats the internal flash memory (all data will be lost).

11111 - Prepares the battery for storage (discharge to 50%).

6.8.16 About

Under the **About** menu the user can see the version and serial number of the NANO⁴.



6.8.17 Shutdown

Pressing the button adjacent to this item on the NANO⁴ screen will shut down the NANO⁴ after confirmation.



7 FLARM Data on the NANO⁴

The NANO⁴ can display FLARM and PCAS traffic on the map or on a radar screen. The radar screen is visible only when a FLARM object is detected by the NANO⁴. In case of a collision warning another screen will be displayed, which will inform the pilot which direction the threat is coming from.

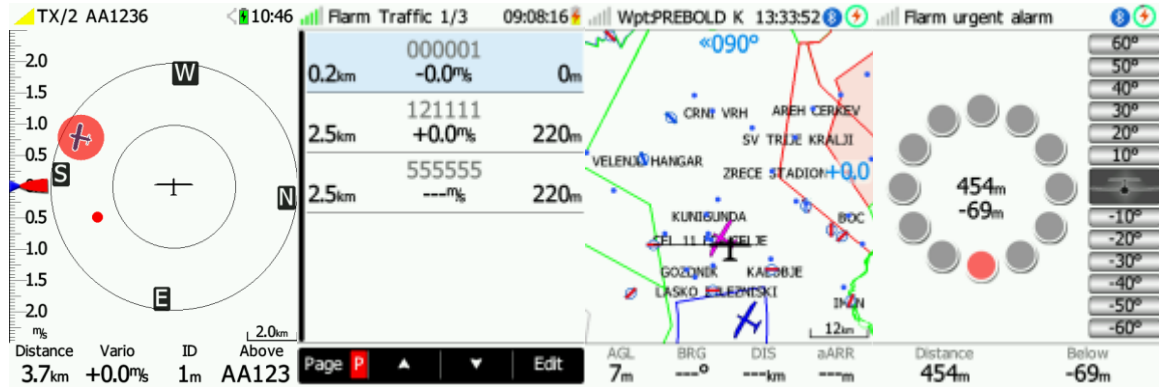

PCAS alerts on the map are represented as a dotted circle with a relative altitude; the PCAS warning is represented by lights on the clock in red or orange.

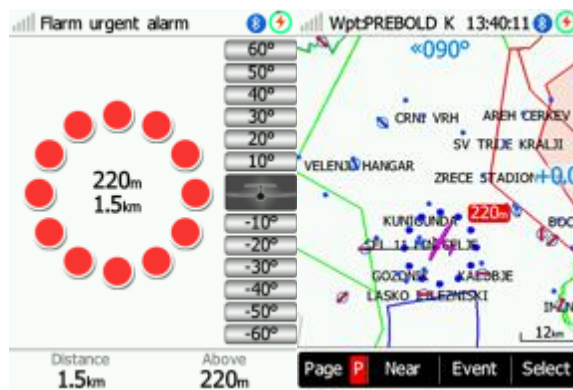

A FLARM warning can be dismissed with a short press of any button. A dismiss time can be configured in setup.

7.1 Connecting a FlarmMouse to the NANO⁴

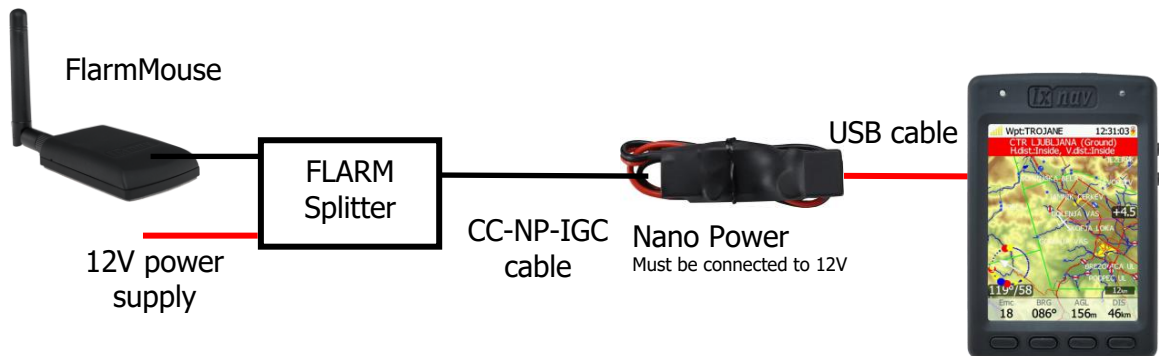

7.2 Connecting a FLARM to the NANO⁴



7.3 Connecting a FLARM to the NANO⁴ using the NanoPower-FL



7.4 Connecting a FLARM/PFlarm to the NANO⁴ using the NanoPower-PF

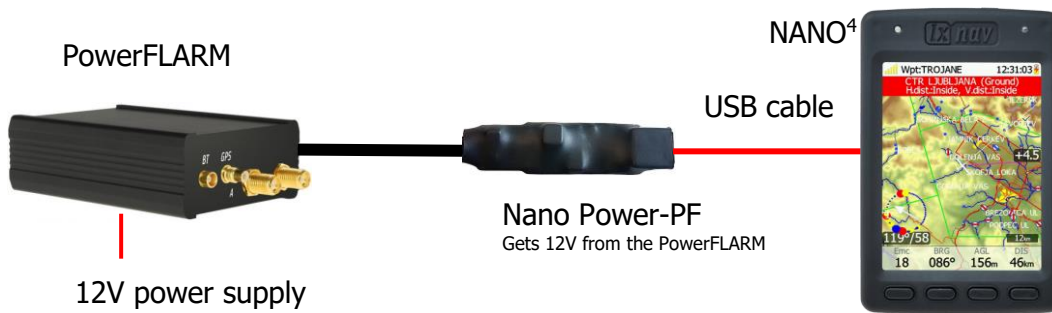

7.5 Connecting a LXxxxx Flarm port to the NANO⁴ using the NanoPower-FL

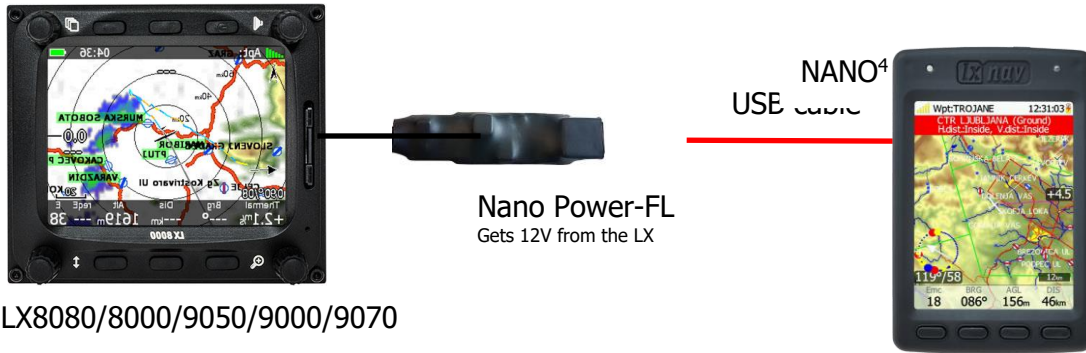

7.6 Connecting a LXxxxx PDA port to the NANO⁴

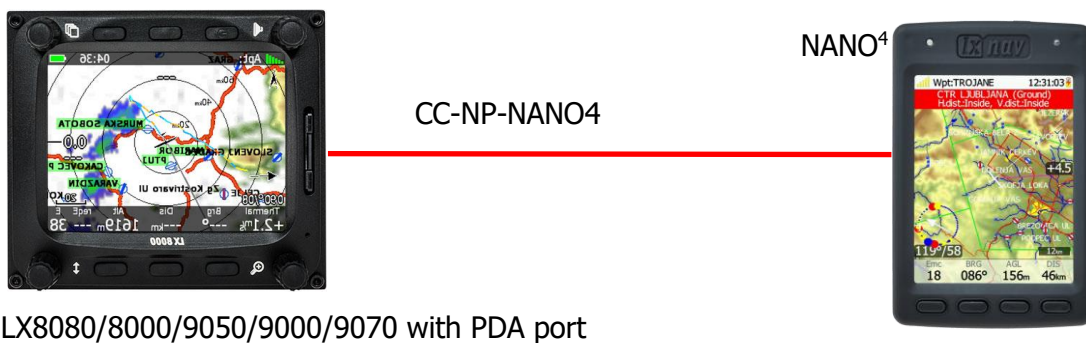

7.7 Connecting a LXxxxx PC port to the NANO⁴

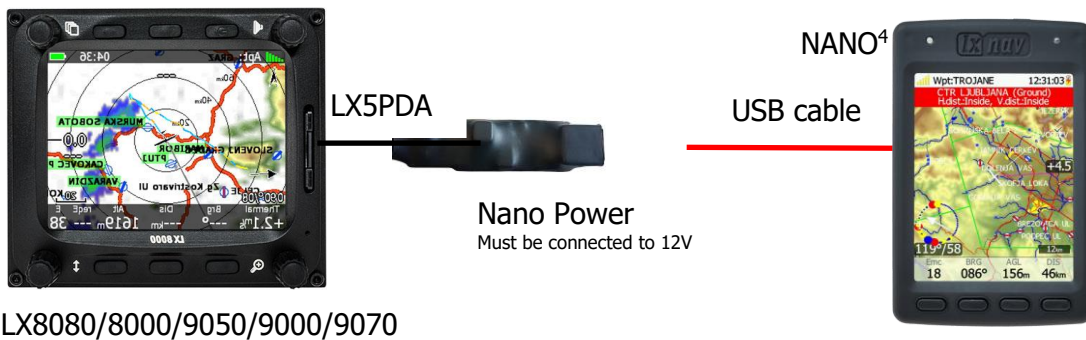

7.8 Connecting NANO⁴ with Serial Number less than 06099

Please note that in all configurations described above a level converter is required for connecting any NANO⁴ device with a serial number less than 06099 with NanoPower.

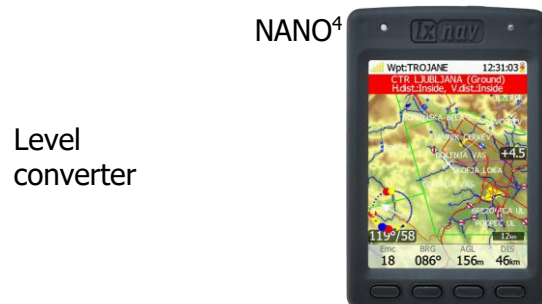



8 Configuring the NANO⁴

8.1 Declarations

One can upload flight declarations to the NANO⁴ in four different ways:

- Directly on the NANO⁴
- Using the NanoConfig program on PC,
- Bluetooth (NanoConfig for Android, Oudie, XCsoar...)
- Serial interface (PDAs, Oudie, XCsoar)

Declarations are stored in the SYSTEM folder in a file called **decl**. The declaration file is formatted as a standard IGC header file. It is recommended that you do not try to modify this file yourself.

8.2 Directly on the NANO⁴

8.2.1 Pilot Information

Detailed information is written in 8.3.1.1.

8.2.2 Declaration and Editing of a Task

In the Task page the pilot can enter or edit the task which will then be automatically declared when he leaves this page. One can select waypoints for a task from the active waypoint file.

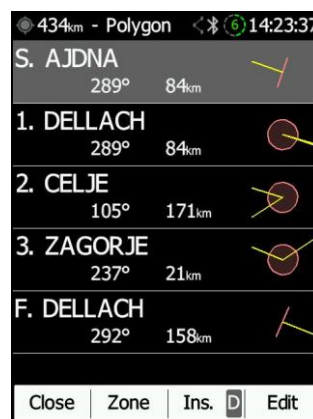

A Task can be entered in a very simple way. In the task page one can press the **edit** button. Using the up or down button one can highlight an existing waypoint or an empty space and then set a new waypoint. By pressing the **Ins.** (insert) button one can start browsing through all the waypoints in the selected CUP file.

Selecting from a list of waypoints is very intuitive. The NANO⁴ will offer the pilot a choice of the sole characters that are available from the available list of waypoint names. Using the button **>>** one can move to the next character (right), the red part of the label **B** indicates one space back or, using a longer push of the button, one character to the left. A similar function is used for the **OK** button where one can confirm a selected waypoint, or cancel the selection of a waypoint using the C. The previous waypoint will then be selected.

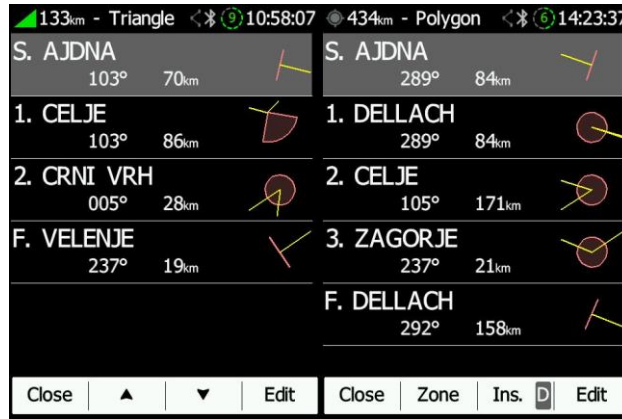

When one is back in the Task menu one can **Insert** or **>Delete [D]** waypoint.

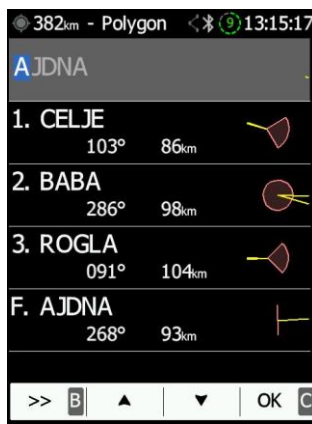

-  To *insert* a waypoint apply a short push on **Ins**. To *delete* a waypoint, depress and hold down the **[D]** button for about (not more than) one second.

Each waypoint can have a custom zone or area applied. These areas can be modified by pressing the Zone button.

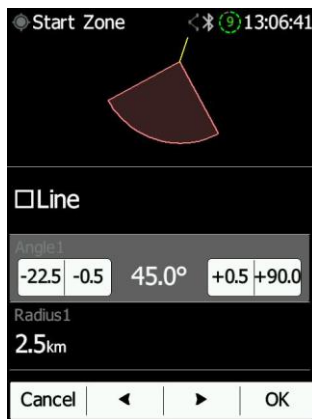

When editing the finish point there are two additional options. Check **navigate to nearest point** and the system will navigate you to the nearest point on the finish zone/line. You can also set the lowest finish altitude by adjusting finish points **elevation**.

8.3 On a PC with NanoConfig for Windows

Use the NanoConfig program to configure the NANO⁴. Using this program, a flight declaration can be uploaded, or various parameters can be modified. The NanoConfig program consists of two major screens: a flight declaration screen and a settings screen.

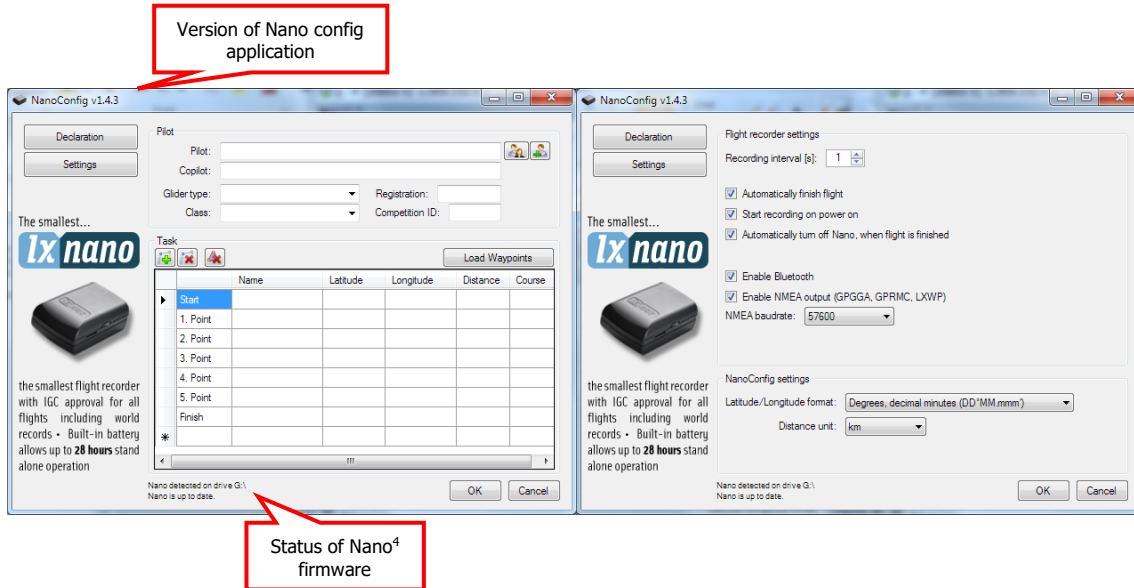



You may toggle between these two screens by pressing the **Declaration** or **Settings** buttons in the upper left corner of the NanoConfig program.

Press the **OK** button to confirm the changes and exit from the program. Press **Cancel** to abandon changes and exit without saving data.

- 
 It is important to run the NanoConfig program directly from the NANO⁴. Do not copy the NanoConfig program to another location since the settings and declarations will not be written properly to the NANO⁴.

The version of the program is written in the lower left corner of the NanoConfig window. When requesting support from LXNAV or reporting a bug, please always include the version of the program in your email.

- 
 All NANO⁴ configuration variables are stored in the SYSTEM folder of the NANO⁴ in a file named "system.ini". It is strongly recommended that you do not modify this file yourself. If you need more information about the "system.ini" file please contact us.
- 
 - NanoConfig for OSX is also available. For further information please contact info@lxnav.com

8.3.1 Using the NanoConfig Program

Run the NanoConfig program and go to the declaration screen. The declaration screen is split into two groups. Pilot and glider related information is in the top group and the task declaration is in the bottom group.

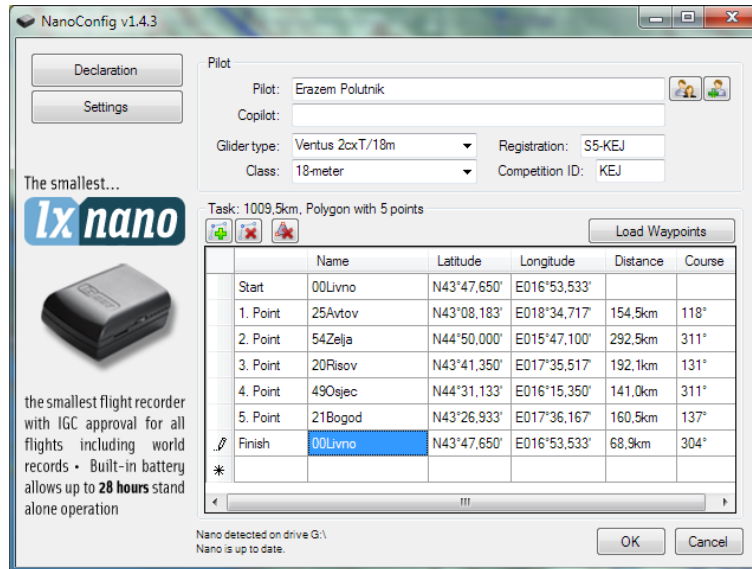

8.3.1.1 Pilot Information

Enter pilot and glider information into the pilot section. In the top right you will find two icons. The first icon will show a list of stored pilot information and the second will add the current pilot information to the list.

Pilot	Copilot	Glider type	Registration	Class	Competition ID
Erazem Polutnik		LS8-18	S5-3118	Standard	EJ
Mitja Spes		EB 28	S5-KKM	Open	MS
Uros Krasovic		HPH 304	S5-JET	18-meter	UK

8.3.1.2 Task Declaration

Before creating a task, you must load the waypoints from which the task will be created. To load waypoints, press the **Load Waypoints** button. Waypoints can be loaded from a CUP formatted file. Once waypoints are loaded you can create a task by entering the names of the waypoints. Use the icons in the upper left corner of the task declaration group to add or delete a point, or to clear the whole task. Task points can also be deleted by pressing the DEL key or can be inserted by pressing the INS key. The task can be also **loaded** from a .CUP file.

8.3.2 Changing Parameters with NanoConfig

Run the NanoConfig program and go to the settings screen which is split into two sections: settings dedicated to the NANO⁴ and settings for NanoConfig.

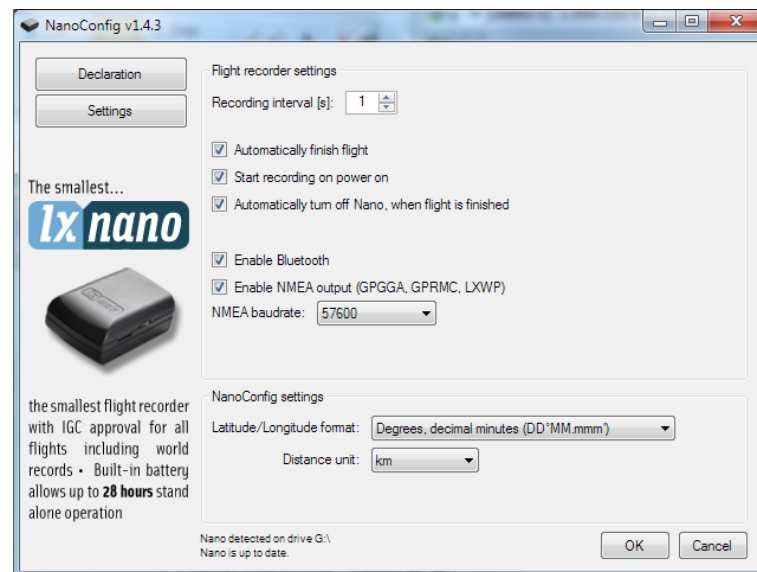

Parameters for the NANO⁴ include the recording interval, a NMEA output and a Bluetooth enable setting.

In NanoConfig you can change the distance units used in the task declaration and the latitude/longitude format.

8.3.2.1 Flight Recording Interval

The flight recording interval is set to one second by default. It is recommended that you keep this setting. Even with the recording interval set to one second, the NANO⁴ can store approximately 28000 hours of flight. Having a recording interval of one second will allow you to do more accurate post-flight analysis and it increases the probability of obtaining a data point in the observation zone.

If you wish to change these settings use the up/down arrow or enter a new value.

8.3.2.2 Automatically Finish Flight

If this option is enabled the flight will automatically finish and be digitally signed once conditions for finishing the flight are met. The NANO⁴ must fulfil the following conditions for 30 seconds: GPS status is OK, ground speed is below 4 m/s, vertical speed is within ± 0.2 m/s and the altitude is below 3000 m.

8.3.2.3 Start Recording on Power On

If this option is enabled recording of a new flight will automatically start when the NANO⁴ is powered on. If this option is disabled the NANO⁴ will start recording when the vertical speed is above 1 m/s, and the ground speed is above 8 m/s. This option is most useful for paragliders.



- When this option is enabled the Automatic finish option is ignored.

8.3.2.4 Automatically Turn Off Nano4 When a Flight Ends

This option is very useful for the NANO⁴ when it is installed permanently into a glider. If this option is enabled the NANO⁴ will automatically switch off 30 minutes after the flight is finished.

8.3.2.5 Bluetooth

Check the **Enable Bluetooth** checkbox if you want to turn it on. By default Bluetooth is disabled.

-  When Bluetooth is enabled the NANO⁴ will consume more power and the total endurance of a new and charged battery will be reduced to approximately 14 hours.

8.3.2.6 NMEA Output

Check **Enable NMEA output** to output NMEA data. The NANO⁴ will transmit the following NMEA sentences: GPGGA; GPRMC, LXWP0 every second and LXWP1 once per minute.

NMEA can be output to either the serial interface or Bluetooth, but not to both simultaneously. Change the NMEA **baud rate** if you want to output NMEA at different baud rates.

8.4 Using Bluetooth or Serial Interface

One can also upload flight declarations using the serial interface or Bluetooth (refer to Section 8.5.1 for Bluetooth pairing). The NANO⁴ must be running in normal operating mode.

-  When connecting through the serial interface one should use the same baud rate as is set for NMEA output on the NANO⁴. When connected through Bluetooth baud rates are not important.

Please refer to the manual for the software used to upload flight declarations (e.g. SeeYou Mobile).

8.5 NanoConfig for Android Devices

You can download NanoConfig from the LXNAV web site or Google Play Market. NanoConfig is a configuration tool for the NANO⁴. You can easily modify all flight recorder parameters, edit

pilot and glider information, edit the declaration and transfer flights from the NANO⁴ to a smart phone.



NanoConfig consists of five tabs: Main, Logbook, Pilot, Task and Settings.

8.5.1 Connecting and Pairing the NANO⁴

When you run NanoConfig on a smart phone the program will first ask you to turn on Bluetooth if it is not already turned on. Via the menu button one can access the scan function which will scan for Bluetooth devices. If the NANO⁴ is turned on and Bluetooth functionality in the NANO⁴ is enabled, it will appear on the scanned list. Choose your Nano⁴. The first time one does it, it will be necessary to pair the NANO⁴ and the Smart Phone together. Read more about pairing in **Section 5.9**.

On the main tab information about the NANO⁴ and its GPS status are shown/displayed. When you want to disconnect simply press **Disconnect**.



8.5.2 Logbook

The first time one accesses this tab the NanoConfig will automatically start reading flights from the connected NANO⁴. Downloading always starts from the most recent to the oldest flight. If you have a lot of flights in the NANO⁴'s memory, the transfer of the logbook can be interrupted with the BACK button.



After the downloading of the logbook data is finished a short press on the desired flight will start the download process. If the flight size is large, the download may take more than one minute. Flights are downloaded into the NanoConfig folder. With a longer push on the flight one can share the downloaded flight with other applications installed on a smart phone (Gmail, SeeYou, OLC (not available), Google Docs, Facebook).

8.5.3 Pilot

Here you can edit information for the pilot, co-pilot and glider. After finishing click **Upload to N4**.

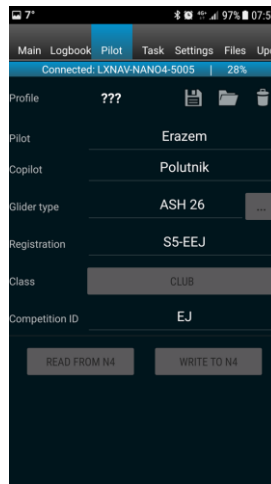

8.5.4 Task

This page is used for creation of new tasks or editing old ones.

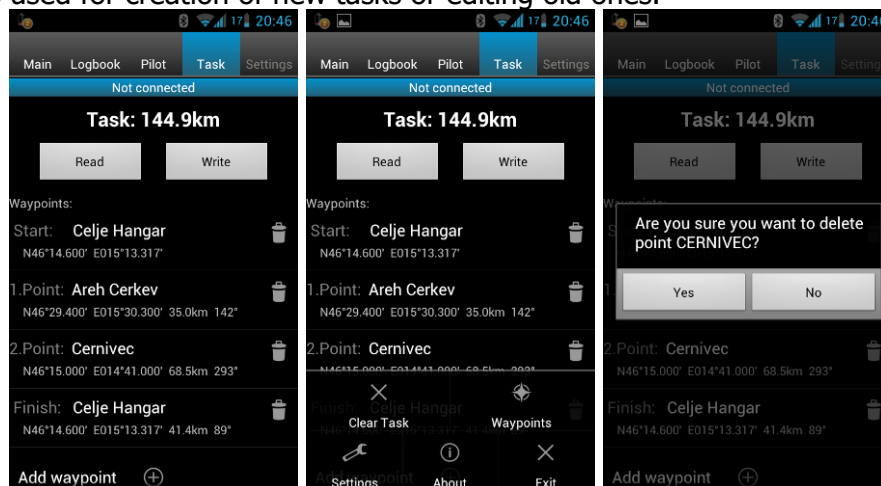

First it is necessary to choose a waypoint file in the CUP (SeeYou) format. To select the CUP file use the MENU button. On some devices you must press the menu button for a long time. To read a task from your NANO⁴ device press **Read**. Press the **Add waypoint** button (+) to add the waypoint to the last position. A long press on the waypoint will give you an option to insert a waypoint. On the right-hand side of waypoint name there is a trash box. Press the trash box to delete the waypoint from the list. After a task has been entered it can be transferred to the NANO³ by pressing the **Write** button.

8.5.5 Settings

In this tab you can configure your NANO⁴. Slide the bar to edit the **recording interval**; a shorter recording interval will allow you to perform more accurate post-flight analysis and it increases the probability of obtaining a data point in the observation zone. You can also turn enable/disable Automatic flight finish and Automatic turn off or edit your NMEA output baud rate.

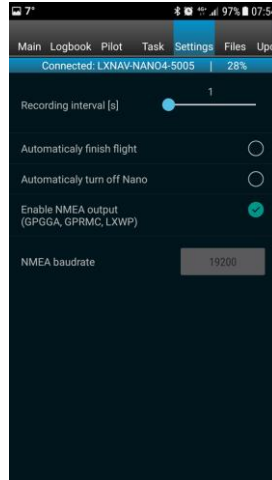

8.5.6 Files

Use this page to select files you want to upload file to your NANO⁴ device. Simply find the file you wish to upload from your smartphone, press it and select **Upload**.

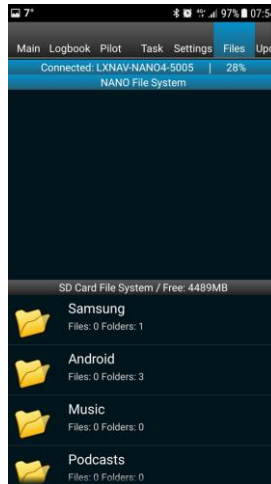

8.5.7 Updates

This page is used to check for application and bootloader updates.

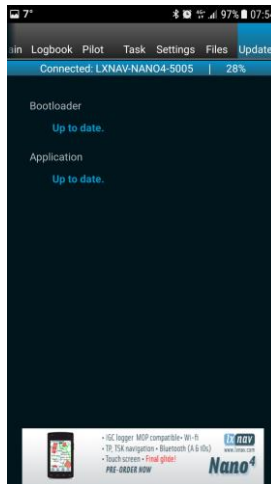

9 Updating Firmware

9.1 Manual Update

Download the latest version from www.lxnav.com. Then simply copy the .zfw file to your NANO⁴ device (root folder) and restart it. On start-up the NANO⁴ will detect the update file and will ask you if you wish to update. Select YES and wait for the process to finish which may take up to 1 minute.



- Wi-Fi update should be done the same way.

9.2 Updating with NanoConfig

After connecting to your NANO⁴ device with NanoConfig the program will automatically inform you about a new version. If you wish to proceed NanoConfig will transfer the .zfw file to the NANO⁴. On start-up the NANO⁴ will detect the update file and will ask you if you wish to update. Select YES and wait for the process to finish.

9.3 Recovery Mode

In case that NANO⁴ was not updated successfully you can use the following procedure to enter into recovery mode.

1. Power OFF the device.
2. Press and hold VOLUME DOWN (side button) + POWER ON.
3. The device will power on in recovery mode.
4. Select YES to restore the factory image.
5. Now you can load the firmware in the normal way as described in Section 9.1 or 9.2.

10 Troubleshooting

Q: My computer does not recognize the NANO⁴ as a USB mass storage device?

A: Make sure that the NANO⁴ is turned off before connecting it to the computer.

Q: Is the internal Li-Ion battery for the NANO⁴ end-user replaceable or would I need to send the unit back to LXNAV or to a dealer to have the battery replaced?

A: Users cannot replace the Li-Ion Battery. Refer to Section 5.13.

Q: I can't read the NANO⁴ on my notebook.

A: Change the power management scheme on your notebook or connect the notebook to a power supply.

Q: When I connect the NANO⁴ to my notebook the message "USB device connected" appears, disappears, appears again, etc. from the laptop screen.

A: Change the power management scheme on your notebook or connect the notebook to a power supply.

Q: Can I open files from the NANO⁴ on the Apple computer?

A: Yes.

Q: I run Ubuntu on my laptop so I cannot run NanoConfig.exe.

A: NanoConfig is a Windows application and runs only on a windows operating system.

Q: Can I declare a task with an OUDIE?

A: Yes—declarations can be done via a serial cable or over Bluetooth.

Q: When I run NanoConfig, I'm getting errors.

A: Probably a Microsoft Net Framework is not installed.

Q: I don't have enough memory in the device to install the necessary map CIT files from your site. Apparently, I have X GB in the file-trashes, but this file does not appear on my computer when the device is connected. How can I empty this trash file? My problem is that no Trash folder shows up in the Nano device when I look at it on my Mac computer.

A: Please use next how-to guide for formatting in Mac OS:<https://www.admfactory.com/how-to-format-usb-flash-drive-to-fat32-in-mac-os/>. It is important that you select "Master Boot Record" scheme before formatting.

11 Revision History

Rev	Date	Comments
	January 2017	Initial release of owner manual
	May 2017	New Sections 6.5.1 and 4.9
	September 2017	New Chapter 0
	February 2018	English correction by JR
	March 2018	Major update. Most chapters updated. Added Sections: 5.2.1, 5.2.2, 5.8.4.1-5.8.4.7, 6.6, 7.5
	April 2018	Added Section 9.3
	May 2018	Updated Sections 4.10, 5.8.7.3, 5.8.11. Added Section 5.8.14, updated Chapter 7
	July 2018	Updated Sections 5.6, 6.5
	September 2018	Complete revision of this manual
	January 2019	Updated Sections 3.5.1, 6.2, 0, 6.8.7, 6.8.8.6
	January 2020	Updated Section 6.8.2
1	April 2020	Updated Section 0
2	August 2020	Corrections to English language text.
3	September 2020	Style update
4	June 2021	Updated Section 7.6, 7.7
5	July 2021	Updated Section 6.8.5, minor fixes
6	November 2021	Updated Section 3.5.1, 8.5.1, 6.8.10
7	January 2022	Style update
8	February 2022	Corrections to English language text.
9	July 2022	Minor corrections
10	December 2022	Minor corrections
11	February 2023	Added chapter 6.8.7.1, 6.8.7.2, updated ch. 6.8.7
12	April 2023	Updated ch. 6.8.7.2
13	February 2024	Updated ch. 6.8.7.2

The pilot's choice



LXNAV d.o.o.

Kidričeva 24, SI-3000 Celje, Slovenia

T: +386 592 334 00 | F: +386 599 335 22 | info@lxnav.com

www.lxnav.com